



# Integra<sup>®</sup> MicroFrance<sup>®</sup>

Integra ENT - Ear catalogue

<b>Table of contents</b>	<b>ii</b>	<b>Syringe</b>	<b>14</b>	<b>Medium monopolar dissecting forceps</b>	<b>36</b>
<b>Ordering and warranty informations</b>	<b>iv</b>	Injection needles	14	Adson	36
<b>Indications - Contraindications</b>	<b>v</b>	Pushing syringe	14	Monopolar cables	36
<b>Diagnosis</b>	<b>2</b>	Replacement tube	14	<b>Tungsten needle-holder</b>	<b>37</b>
Angled probe caustic holder	3	Silicon grey washer luer	14	<b>Fine haemostatic forceps</b>	<b>38</b>
Cotton carrier	3	Silicon white washer	14	<b>Medium haemostatic forceps</b>	<b>39</b>
Hooks	3	Syringe luer-lock	14	<b>Strong haemostatic forceps</b>	<b>40</b>
Kidney bowl	2	<b>Elevator, raspatory</b>	<b>15</b>	Forceps 2x3 prongs	40
Loop	4	<b>Curved raspatory</b>	<b>16</b>	Forceps serrated jaws	40
Micro forceps	5	<b>Retractor</b>	<b>17</b>	Forceps with teeth «T» tip	40
Oval loop	4	<b>Self-retaining retractor</b>	<b>19</b>	Towel clamp	40
Tuning fork	2	Curved	19	<b>Suction tube with finger control</b>	<b>41</b>
<b>Myringoplasty</b>	<b>6</b>	Large size	22	<b>Micro suction tube - adapters</b>	<b>42</b>
Knife blade lancet	6	Straight	21	Curved suction tube	42
Lancet handle	6	With blade	20	Luer-lock US adapter	42
Myringoplasty lancet	6	<b>Curette</b>	<b>23</b>	Suction tube adapter	42
Scalpel handle	7	<b>Mallet</b>	<b>24</b>	<b>Micro suction tube</b>	<b>43</b>
Sterile knife blade lancet	7	<b>Chisel, gouge</b>	<b>25</b>	Angled suction tube	44
“T” tube insertor	6	<b>Rongeur</b>	<b>26</b>	Blunt eyes suction tube	44
<b>Scalpel</b>	<b>8</b>	<b>Small scissors, pointed blades</b>	<b>28</b>	Malleable suction tube	44
Knife blades	8	<b>Small scissors, blunt tip</b>	<b>29</b>	MicroLite® malleable suction tube	44
Scalpels	8	<b>Small scissors, blunt tip</b>	<b>29</b>	MicroLite® suction tube adapter	44
<b>Speculum</b>	<b>9</b>	<b>Metzenbaum scissors, small</b>	<b>30</b>	Suction tube with luer-lock connection	43
33mm	10	Fine blades	30	<b>Forceps serrated jaws, Alligator forceps</b>	<b>45</b>
35mm	10	Tungsten blades	30	<b>Micro scissors - Cup forceps</b>	<b>46</b>
40mm	9	<b>Mayo Scissors</b>	<b>31</b>	<b>Microcut forceps</b>	<b>47</b>
42mm Oblique black finish	10	Mayo Scissors	31	Malleus nipper forceps	47
43mm	9	Mayo-Stillie Scissors	31	Microcut forceps	47
43mm Oblique	10	Scissors, straight pointed blades	31	<b>Micro piston forceps</b>	<b>48</b>
43mm Oval	10	<b>Fine dissecting forceps</b>	<b>32</b>	<b>Knife</b>	<b>49</b>
45mm	9	Dissecting forceps serrated jaws	32	Chisel	49
Boucheron	10	Dissecting forceps with teeth	32	Double knife	49
Speculum pneumo otoscope	9	Dissecting forceps with teeth and plateform	32	Knife	49
<b>Speculum with handle</b>	<b>11</b>	Forceps with horizontal teeth and plateform	32	Knife mirror	49
Dilator	11	<b>Adson dissecting forceps</b>	<b>33</b>	Lancet knife	49
Self-retaining	11	Adson	33	Oval knife	49
Speculum with handle	11	Adson-Brown	33	Sickle knife	49
<b>Flexible tension arm</b>	<b>12</b>	Adson-Tubiana	33	Suction round knife	49
Articulated kneecap	12	<b>Medium dissecting forceps</b>	<b>34</b>	<b>Micro elevator - mirror - raspatory</b>	<b>50</b>
Ear quick-lock speculum	12	<b>Medium bipolar dissecting forceps</b>	<b>35</b>	Curved elevator	50
Malleable blade	12	Adson	35	Double curved elevator	50
Self-retaining speculum	12	Bipolar cables	35	Micro mirror	50
Speculum holder	12	Magnan	35	Micro raspatory	50
Table clamp	12	<b>Angled dissecting forceps</b>	<b>13</b>	Whirlybird elevator	50
Tension arm	12				

<b>Micro curette</b>	<b>51</b>	<b>Causse set</b>	<b>62</b>	<b>Selesnick set</b>	<b>74</b>
<b>Micro pick - Tenotome probe</b>	<b>52</b>	<b>Presutti set for endoscopic surgery of the ear</b>	<b>64</b>	Bipolar forceps	75
Curved pick	52	Alligator forceps	65	Cup forceps	74
Curved pick, blunt	52	Curved curette double-ended	64	Curette	74
Straight pick	52	Fascia press	65	Curved self-retaining retractor	75
Tenotome probe	52	Lancet knife	64	Elevator	74
<b>Micro hook</b>	<b>53</b>	Suction tube elevator	64	Hook	74
Hook, tip angled shaft	53	Suction tube with finger control	65	Knife	74
Hook, tip bent shaft	53	Wire crimper forceps	65	Scissors	74
Hook, tip straight shaft	53	<b>Thomassin set</b>	<b>66</b>	Sterilization case	75
<b>Miscellaneous micro hook - Raspatory</b>	<b>54</b>	Angled suction tube	66	<b>MicroFrance® drilling</b>	<b>76</b>
Curved hook	54	Cup forceps	67	6 sided burrs	76
Incudostapedial joint knife	54	Double elevator	66	Diamond burrs	76
Micro hook, spoon handle	54	Forceps, serrated jaws	67	Diamond knife	76
Micro raspatory	54	Hook	66	Drill burr	76
<b>Micro coagulation</b>	<b>55</b>	Raspatory	66	Perforer six sided burr	76
Bipolar cables	55	Sterilization case	67	Sterilization case	76
Bipolar forceps	55	Sterilization tray	67	Sterilization tray	76
Curved monopolar elevator	55	Suction tube adapter	66	Tungsten helicoidal pear burr	76
Curved monopolar pick	55	<b>Otoneurosurgery</b>	<b>68</b>	Tungsten round burr	76
Monopolar cables	55	Angled curette double-ended	73	<b>Stainless steel cup, tray - Surgical instrument oil</b>	<b>77</b>
<b>Micro measuring rod</b>	<b>56</b>	Articulated self-retaining retractor	70	Cup	77
Angled shaft	56	Ball seeker	73	Surgical instrument oil	77
Columella distance measuring rod forceps	56	Blunt eyes suction irrigation tube	69	Tray	77
Malleable shaft	56	Blunt eyes suction tube	68	<b>Stainless steel sterilization tray and case</b>	<b>78</b>
Ossiculoplasty sizer	56	Blunt eyes suction tube with finger control	69	Stainless steel sterilization case	78
Straight shaft	56	Blunt straight pick	73	Stainless steel sterilization tray	78
<b>Prosthesis placement</b>	<b>57</b>	Curved elevator	72	<b>Plastic sterilization case</b>	<b>79</b>
Cartilage cutting block	58	Curved pick	73	<b>Numerical index</b>	<b>80</b>
Fascia press	58	Curved self-retaining retractor	71		
Ossicle holding clamp	57	Fenestrated curette	72		
Ossiculoplasty sizer	57	Forceps	70		
Punch for silastic	57	Hook	72		
Replacement blade	58	Magnan hooks	73		
Wire guide	57	Micro aspirateur	69		
<b>Piston placement</b>	<b>59</b>	Mom Instruments	73		
Hand drill pick	59	Oval knife	73		
Piston trimming gauge	59	Scissors	70		
Preparation glass plate	59	Sickle knife	73		
<b>Otoplasty - Holder</b>	<b>60</b>	Sterkers instruments	72		
Otoplasty	60	Whirlybird elevator	72		
Temporal bone specimen holder	60				
<b>Suction foot switch</b>	<b>61</b>				
Replacement accessories	61				
Suction foot switch	61				

**Pricing :**

Prices stated in specific written quotations are firm for thirty days from the date given, and are otherwise subject to change without prior notice. Pricing terms stated on written agreements are governed by such agreements.

**Minimum Order Requirements :**

The minimum ordering amount is €250 (Integra reserves the right to apply €20 handling fees and transport fees for any order below €250). For partial unit orders, please contact the customer service to obtain a quote.

**Administrative fees :**

Administrative fees may be charged for any order.

**Ordering Procedure :**

A written purchase order is required for the purchase of Integra MicroFrance® products.

**Acceptance of Orders :**

Orders are accepted upon approval by Integra Customer Service.

**Return Policy :**

- Authorization from Customer Service must be obtained prior to returning product.
- Sterile product must be returned in unopened, undamaged cartons, packed to prevent damage.
- Non-sterile product must be returned in unused saleable condition in original package.
- A credit note will be issued for products returned less than ninety days from shipment date with a 20% restocking fee, provided that the product being returned is not damaged and it is possible to verify that the product has not been used or opened.

**Integra Limited Warranty**

Please refer to the warranty included in the packaging of each product to know the applicable warranty.

**Contact Customer service :**

**France / International**

+33 (0) 470 67 98 00  
+33 (0) 470 67 98 20 (Fax)  
microfrance@integralife.com

**Benelux**

+32 (0) 2 257 4130  
+32 (0) 2 253 2466 (Fax)  
custsvcbenelux@integralife.com

**United Kingdom**

+44 (0) 1264 312 725  
+44 (0) 1264 312 821 (Fax)  
custsvcuk@integralife.com

**Germany**

+49 (0) 2102 5535 6200  
+49 (0) 2102 5536 636 (Fax)  
custsvcgermany@integralife.com

## MicroFrance® ENT Instrumentation

### INDICATIONS

- All the medical devices showed in this catalogue have indications for diagnosis and/or ENT surgery.
- Sizes are not contractual and are given for information purposes only.

### CONTRAINDICATIONS

- Do not use in indications other than the indications mentioned in the DFU or Labeling.

## How to read the catalogue

The diagram illustrates the layout of a catalogue page. At the top, there is a green header with the word "Consultation" and the INTEGRA logo. Below this, several instrument images are shown, each with a circular detail view above it. The detail views are labeled "Marquet", "Day", "Legent", and "Porte-coton". The main images are labeled with their respective angles: 90°, 90°, 90°, 45°, 140mm, and 110mm. Below the images is a table with columns for product names and dimensions. The table is annotated with "Explanatory table see below".

Annotations include:

- Title and/or product family
- Detail view of the instrument
- Instrument to a 1/1 scale except where mentioned otherwise
- Explanatory table see below

Micro crochets mousse 90°		Micro crochets mousse 45°		Porte-coton	Sonde stylet
160mm		150mm		140mm	110mm
MCD805	2,0mm	MCD950	0,8mm	7779-2	7771
MCD805A	2,5mm	3124027	1,0mm		
		3124028	2,0mm		
		3124029	2,5mm		

Document destiné à l'Europe, au Moyen-Orient et à l'Afrique.

## Explanation of the table reference and complementary product description

Title or subtitles	
global complementary description	
Product Ref.1	complementary description1
Product Ref.2	complementary description2



Tuning fork with weights

3724231	128VD
3724232	256VD



Tuning fork without weights

3724233	512VD
3724234	1024VD
3724235	2048VD



Stainless steel kidney bowl

7875 <sup>(D)</sup>
---------------------

<sup>(D)</sup> Distributed by Integra MicroFrance SAS (France)

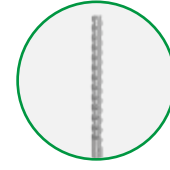
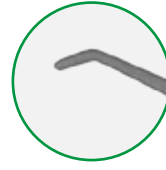

**Marquet**

**Day**

**Legent**



90°



90°



90°



45°



Blunt hook 90°

Blunt hook 45°

Cotton carrier

Angled probe

165mm		MCO950		150mm	
MCO805	2,0mm		0,8mm	3724027	1,5mm
MCO805A	2,5mm			3724028	2,0mm
				3724029	2,5mm





165mm	
MCO807	1,0mm

140mm	
7719-2	

110mm	
7731	

45°

**Buck**

- n°00  2,0x1,0mm
- n°0  2,5x1,5mm
- n°1  3,0x2,0mm
- n°2  4,0x2,5mm
- n°3  4,5x3,0mm



**Sprague**



**Trautmann**



**Saint-Paul**



**Snellen**



**Billeau**



**Snellen**



Loop

	165mm	
45°		
3724011	n° 00	3724016
3724012	n° 0	3724017
3724013	n° 1	3724018
3724014	n° 2	3724019
3724015	n° 3	3724020

Other loop

180mm	170mm	90mm
3724023	7888	7886
2,0mm	4,0mm	2,5mm
3724024		
3,0mm		

Oval loop

140mm	160mm	160mm
7885	3724055	7718
4,5mm	2,0mm	4,0mm
	3724056	
	3,0mm	
	3724057	
	4,0mm	

Oval loop tip curved

200mm
7885A
4,0mm



WL Working Length

Micro forceps

Hartmann



3721000

2,0x6,0mm

WL 55mm

Tobey

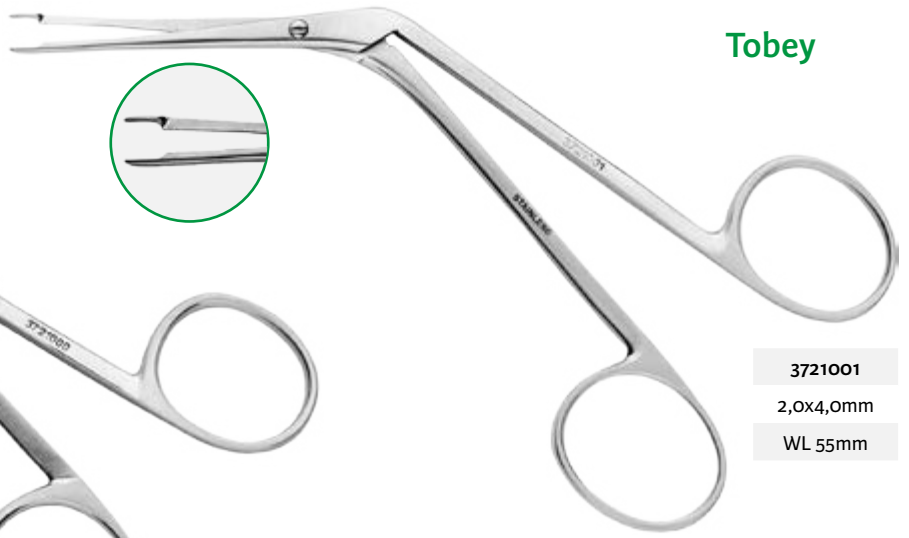

3721001

2,0x4,0mm

WL 55mm

Strümpel



3721005

2,5x6,0mm

WL 80mm

Hartmann



MCO13A

4,0x0,8mm

MCO13B

7,0x1,5mm

MCO13D

5,0x1,0mm

Myringoplasty lancet

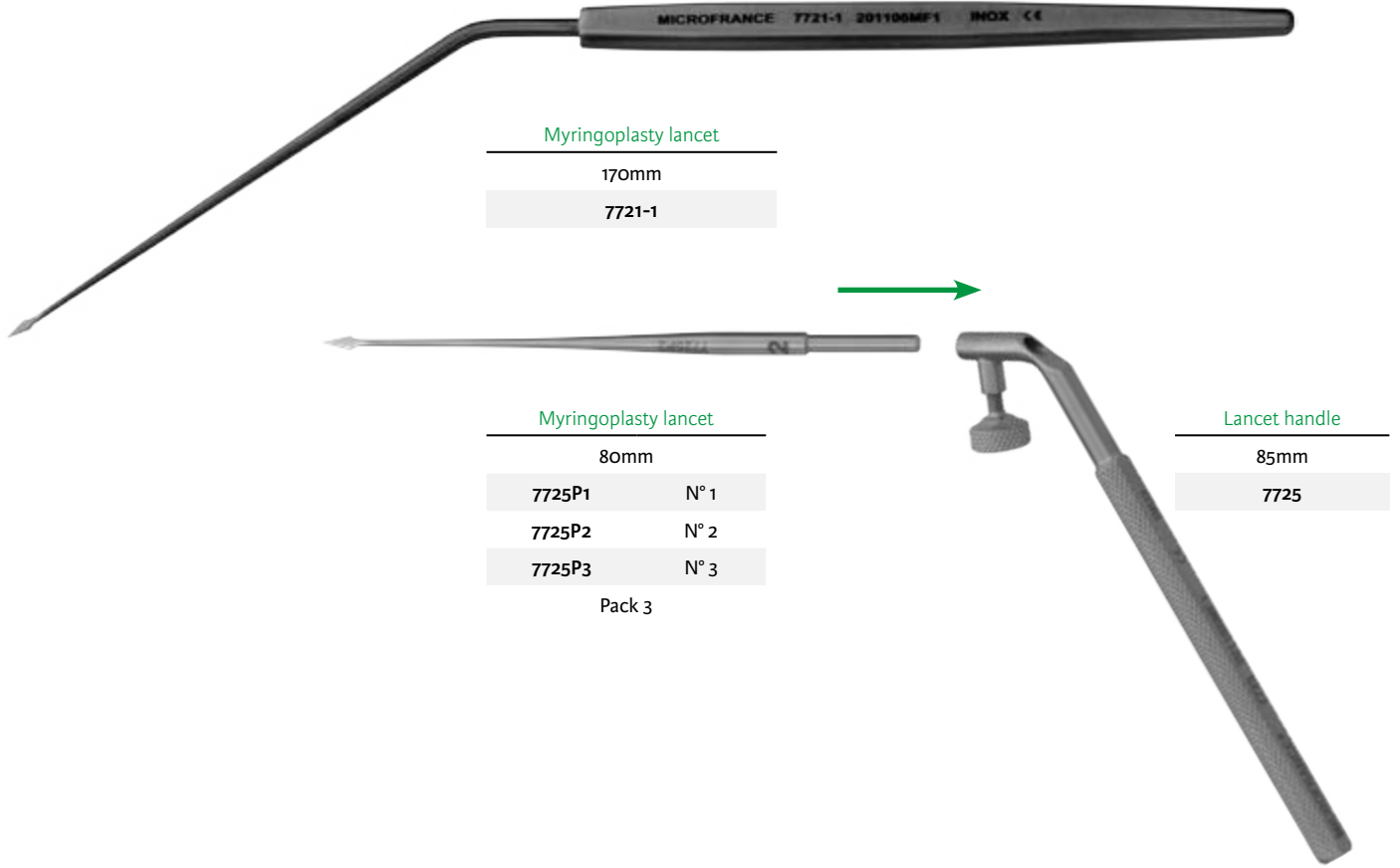

“T” tube insertor

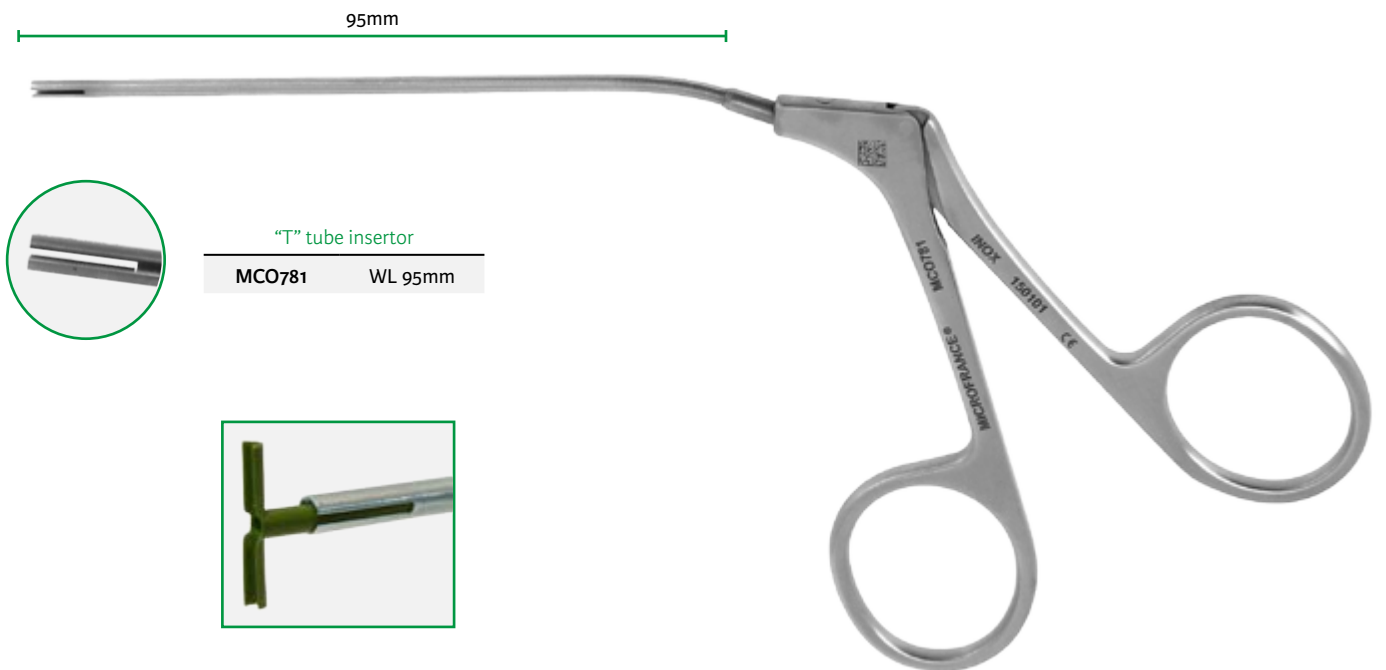

WL Working Length



Myringotomy kit for adult / children

**0208**

Pack of 10 sterile units

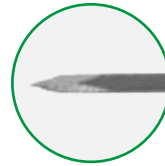

Knife blade lancet with handle

Pack of 10 sterile unitss

**1411000**

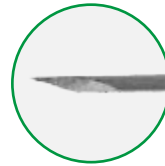

Knife blade lancet with handle

Pack of 10 sterile unitss

**1411050**

**Chuck**



Chuck scalpel handle

**1352321**

100mm

**Knife blade lancet**

Pack of 5 sterile units

Used with handle ref. 1352321



Knife blade upcutting angled use

**1458230**

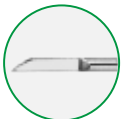

Knife blade downcutting angled use

**1458231**

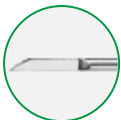

Knife blade straight use

**1458232**



Knife blade lancet tip angled use

**1458233**



Knife blade lancet straight use

**1458234**

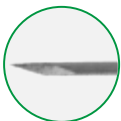

Knife blade narrow use

**1458275**



Knife blade lancet angled use

**1458276**

Scalpels



CP821B	100mm
CP821C	130mm
CP821D	150mm
CP821E	190mm

120mm

1003IG<sup>(D)</sup>

160mm

1005I<sup>(D)</sup>

200mm

1003LI<sup>(D)</sup>

150mm

CP821

120mm

1004IG<sup>(D)</sup>

130mm

CP821C

Blades 11/15

23

SM63<sup>(D)</sup> SM64<sup>(D)</sup> SM65<sup>(D)</sup>

<sup>(D)</sup> Distributed by Integra MicroFrance SAS (France)

## Speculum

## Farrior



3724103

43mm

3724101	Ø 5,0mm	N° 1
3724102	Ø 6,0mm	N° 2
3724103	Ø 7,0mm	N° 3
3724104	Ø 8,0mm	N° 4
3724105	Ø 9,0mm	N° 5
3724106	Ø 10,0mm	N° 6
3724107	Ø 10,5mm	N° 7

## Le Mée

9913-4<sup>(D)</sup>

45mm

9913-1 <sup>(D)</sup>	Ø 2,0mm	N° 1
9913-2 <sup>(D)</sup>	Ø 2,5mm	N° 2
9913-3 <sup>(D)</sup>	Ø 3,0mm	N° 3
9913-4 <sup>(D)</sup>	Ø 4,0mm	N° 4
9913-5 <sup>(D)</sup>	Ø 5,0mm	N° 5
9913-6 <sup>(D)</sup>	Ø 6,0mm	N° 6
9912-7 <sup>(D)</sup>	Ø 7,0mm	N° 7
9912-8 <sup>(D)</sup>	Ø 8,0mm	N° 8
9912-9 <sup>(D)</sup>	Ø 9,0mm	N° 9

## Legent



8812-3

40mm

Pack 1	Pack 100		
8812-1	8814T1	Ø 3,0mm	N° 1
8812-2	8814T2	Ø 4,5mm	N° 2
8812-3	8814T3	Ø 5,0mm	N° 3
8812-4	8814T4	Ø 5,5mm	N° 4
8812-5	8814T5	Ø 6,0mm	N° 5

## Legent



8820

## Speculum pneumo otoscope

<sup>(D)</sup> Distributed by Integra MicroFrance SAS (France)

**Boucheron**



3724093

Boucheron

3724093	30mm	Ø 3,0mm	N° 1
3724094	32mm	Ø 4,0mm	N° 2
3724095	34mm	Ø 4,5mm	N° 3
3724096	35mm	Ø 5,0mm	N° 4
3724097	35mm	Ø 5,5mm	N° 5
3724098	35mm	Ø 6,5mm	N° 6
3724099	37mm	Ø 7,5mm	N° 7
3724100	37mm	Ø 9,0mm	N° 8

**Farrior**



3724108

43mm Oval

3724108	4,5x6,0mm	N° 1
3724109	5,5x7,0mm	N° 2
3724110	6,5x8,0mm	N° 3
3724111	7,5x9,0mm	N° 4
3724112	8,0x10,0mm	N° 5
3724113	9,0x11,0mm	N° 6
3724114	10,0x12,0mm	N° 7



3724122

43mm Oblique

3724122	5,0x6,0mm	N° 1
3724123	6,0x7,0mm	N° 2
3724124	7,0x8,0mm	N° 3
3724125	8,0x9,0mm	N° 4
3724126	9,0x10,0mm	N° 5
3724127	10,0x11,2mm	N° 6
3724128	11,0x12,5mm	N° 7

**Hartmann**



3724142

33mm

3724141	Ø 4,5mm	N° 1
3724142	Ø 5,5mm	N° 2
3724143	Ø 6,5mm	N° 3
3724144	Ø 7,5mm	N° 4
3724150	Ø 2,5mm	



3724145

35mm

3724145	4,5x5mm	N° 1
3724146	5,5x6mm	N° 2
3724147	6,5x7mm	N° 3
3724148	7,5x8mm	N° 4
3724151	2,5x3mm	

**Speculum, oblique black finish**



3724407

42mm

3724401	3,0x4,0mm	N° 1
3724402	3,5x4,5mm	N° 2
3724403	4,0x5,0mm	N° 3
3724404	4,5x5,5mm	N° 4
3724405	5,0x6,0mm	N° 5
3724406	5,5x6,5mm	N° 6
3724407	6,0x7,0mm	N° 7
3724408	6,5x7,5mm	N° 8
3724409	7,0x8,0mm	N° 9
3724410	7,5x8,5mm	N° 10
3724411	8,0x9,0mm	N° 11

Hartmann



160mm

7898

Tieck-Halle



130mm

7897

Beckman



140mm

7899

Vienna



140mm

MCO233

Dilator



140mm

MCO237

Self-retaining

Flexible tension arm

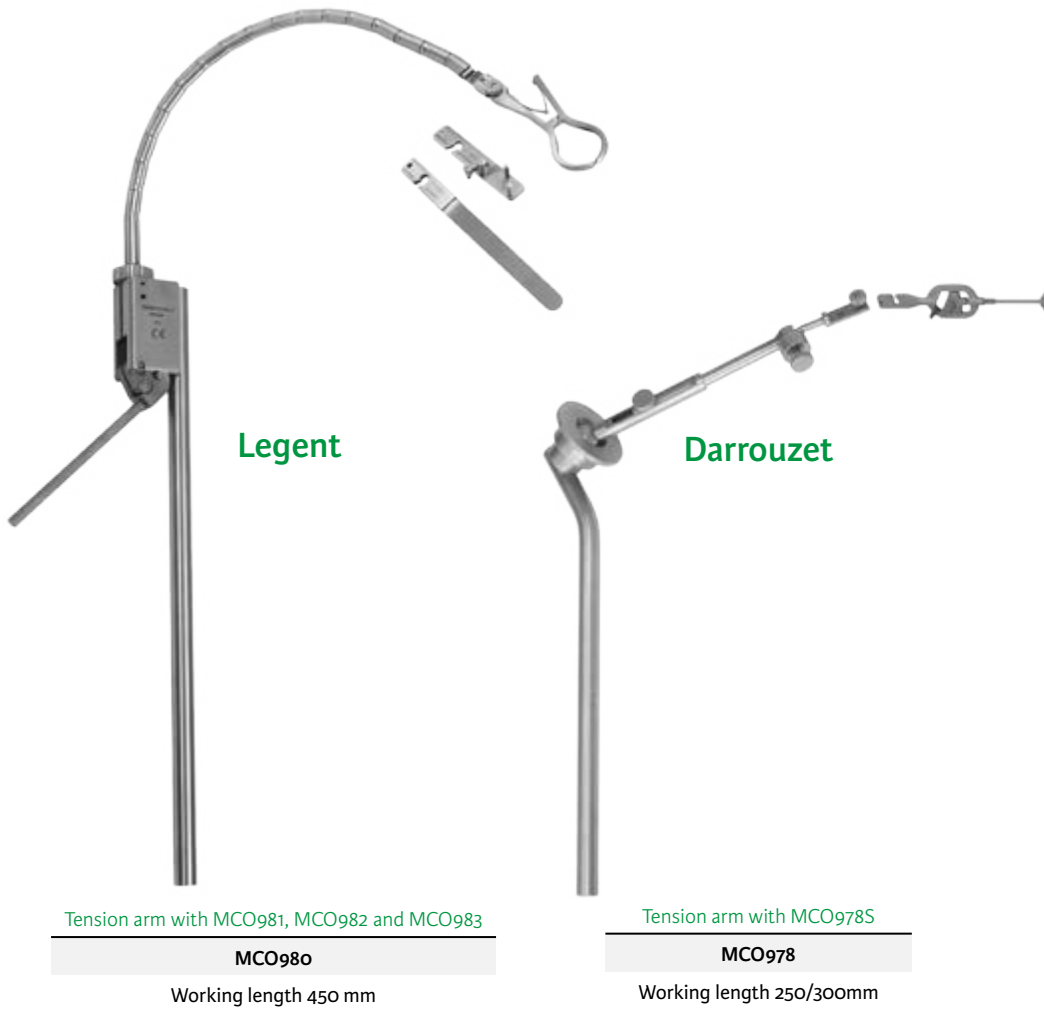

Legent

Darrouzet

Tension arm with MCO981, MCO982 and MCO983

**MCO980**

Working length 450 mm

Tension arm with MCO978S

**MCO978**

Working length 250/300mm

Table clamp



**CEV984**

**CEV985**

Accessories for flexible tension arm

Self-retaining speculum

Ear quick-lock speculum

Speculum holder

Malleable blade

Articulated kneecap

Devèze



**MCO981D**

**MCO978S**

**MCO981**

Otologic

**MCO982**

Nasal

**MCO983**

12,0x85,0mm

**MCO983-4**



Gruenwald

Lucae

Lucae

Politzer



200mm

3711007

140mm

3711002

1,50x15mm

3711004

1,25x15mm

150mm

7726MF

1,10x12mm

7727

spoon jaws

7728

with teeth

120mm

7732-1

1,50x14mm

3711102

2,0x14mm

7733

curette

7734

with teeth

160mm

3711103

1,50x14mm

Syringe luer-lock high pressure 5cc

Génia

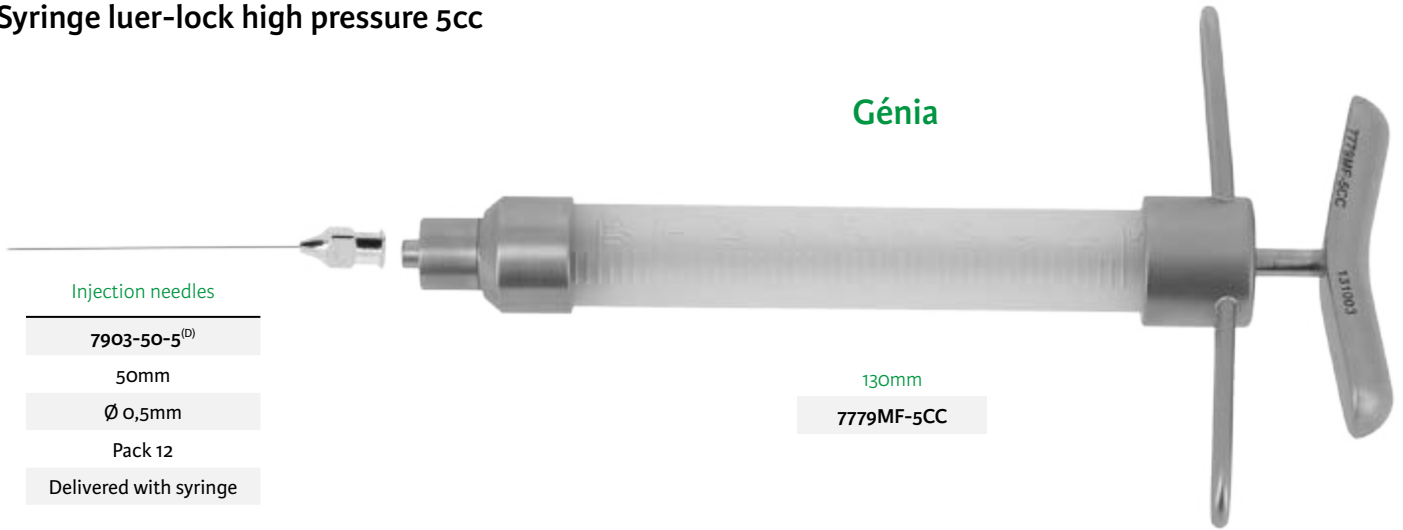

Injection needles

7903-50-5<sup>(D)</sup>

50mm

Ø 0,5mm

Pack 12

Delivered with syringe

130mm

7779MF-5CC

Silicon grey washer luer

Replacement tube

Silicon white washer



7779MF-2

Pack 6



7779MF-3



7779MF-1

Pack 6



Pushing syringe

7783-12

Pack 2



Chouard



for disposable syringe luer-lock 12cc

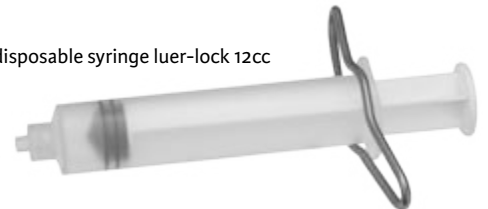

Injection needles

110mm

3714247

3714249

bayonet shaft

3734108

3734107

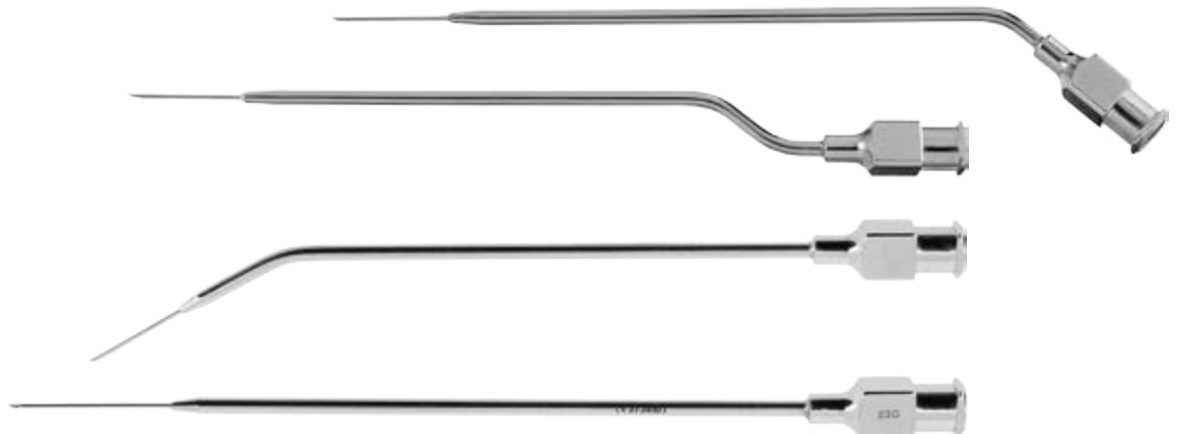

<sup>(D)</sup> Distributed by Integra MicroFrance SAS (France)

Lempert



160mm

3714115

2,0mm

3714116

3,0mm



190mm

CP985

5,0mm

Sébileau



180mm

MCO305

8,5mm

Freer



160mm

MCO803

2,5mm

Fleury



185mm

CP611

5,0mm

Howarth



220mm

CP625

Cottle



220mm

CP626

McKenty



240mm

CP627

Heavy

Farabeuf

Fleury

Sébileau

Plester



195mm

3724059

6,5mm



150mm

7787-10

10mm



170mm

MCO979

6,5mm



150mm

CP825

4,0mm



180mm

MCO988

7,5mm



Army navy



210mm

3714018

Farabeuf



140mm

7768-1

120mm

7768

140mm

Desmarres



140mm

CP822-12

12mm

CP822-10

10mm

CP822-14

14mm

Gillies



180mm

CP17

3,0mm

CP17-1

2,0mm

Gillies



145mm

CP17-3

2,0mm

CP17-2

3,0mm

Humby



110mm

CP941

145mm

CP628

5,0mm

Knapp

Blair

Guthrie

Volkman

Senn-Miller



150mm

3714027

8,0mm

3714028

blunt



140mm

3714184



140mm

CP21-3

sharp

CP21A-3

blunt



130mm

3714044

2,0mm



150mm

7782-1-2



180mm

CP335



160mm

CP609

3 sharp prongs

3714032

3 blunt prongs

### Weitlaner

110mm

O-28-8



### Schuknecht

130mm

O-28-2



### Weitlaner-Wullstein

130mm

O-28-1

### Weitlaner

130mm

O-28

3x4 sharp prongs

3724332

3x4 blunt prongs

**Plester**



110mm

**0-28-3**

Sharp prongs right

**0-28-4**

Sharp prongs left

**Bellucci-Wullstein**



110mm

**3724070**

Blunt prongs left

**3724069**

Blunt prongs right

**Perkins**

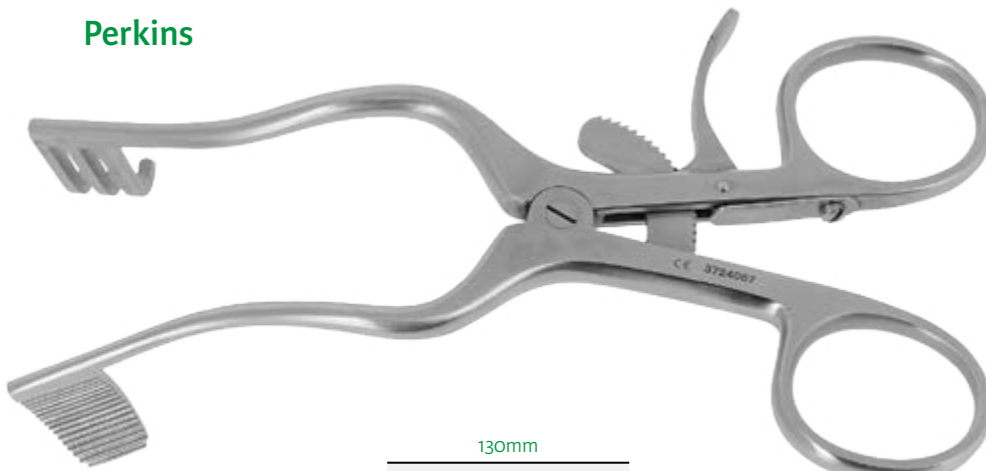

130mm

**3724067**

Blunt prongs right

**3724066**

Blunt prongs left



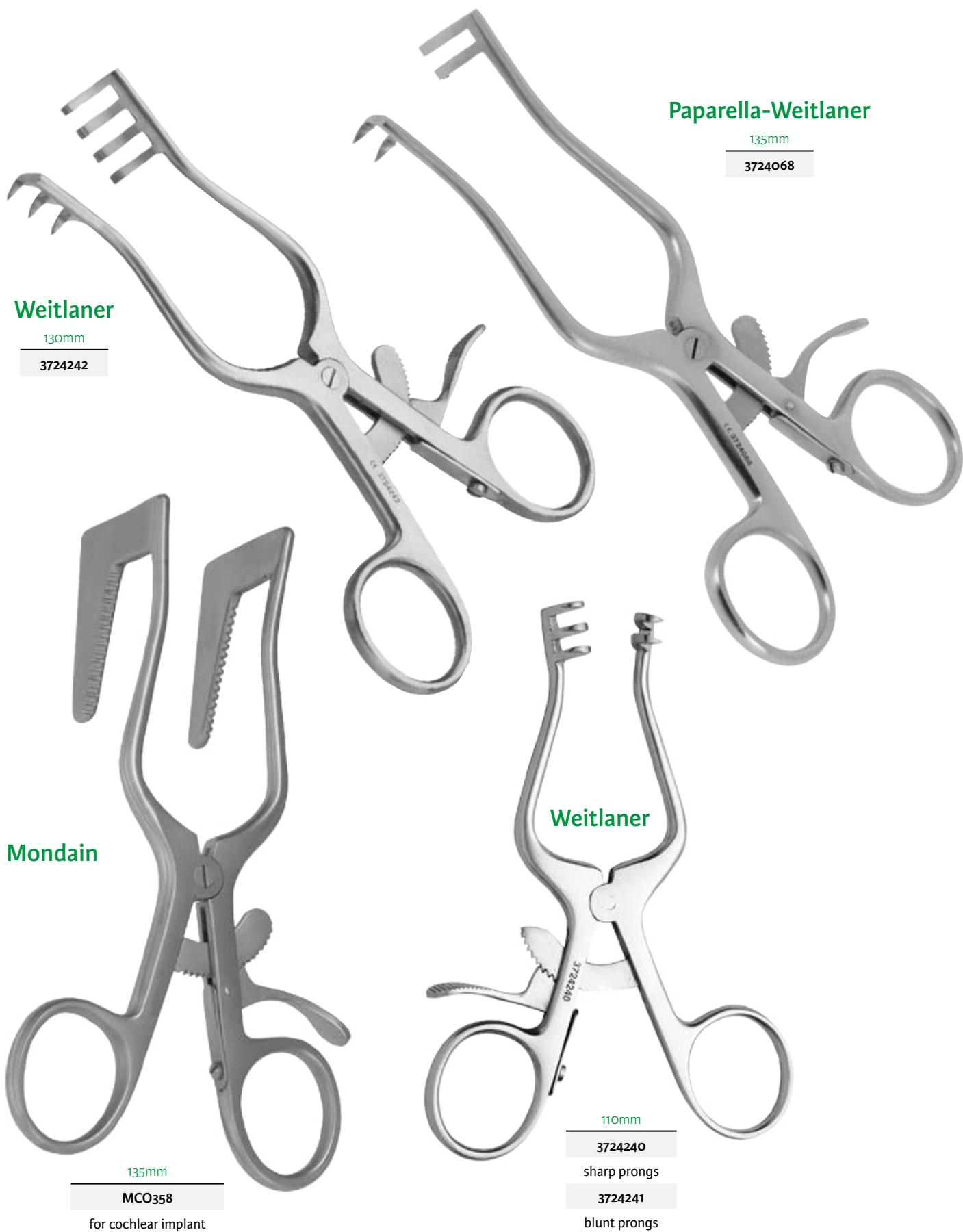

**Weitlaner**

130mm

3724242

**Paparella-Weitlaner**

135mm

3724068

**Mondain**

135mm

MCO358

for cochlear implant

**Weitlaner**

110mm

3724240

sharp prongs

3724241

blunt prongs

**Weitlaner**

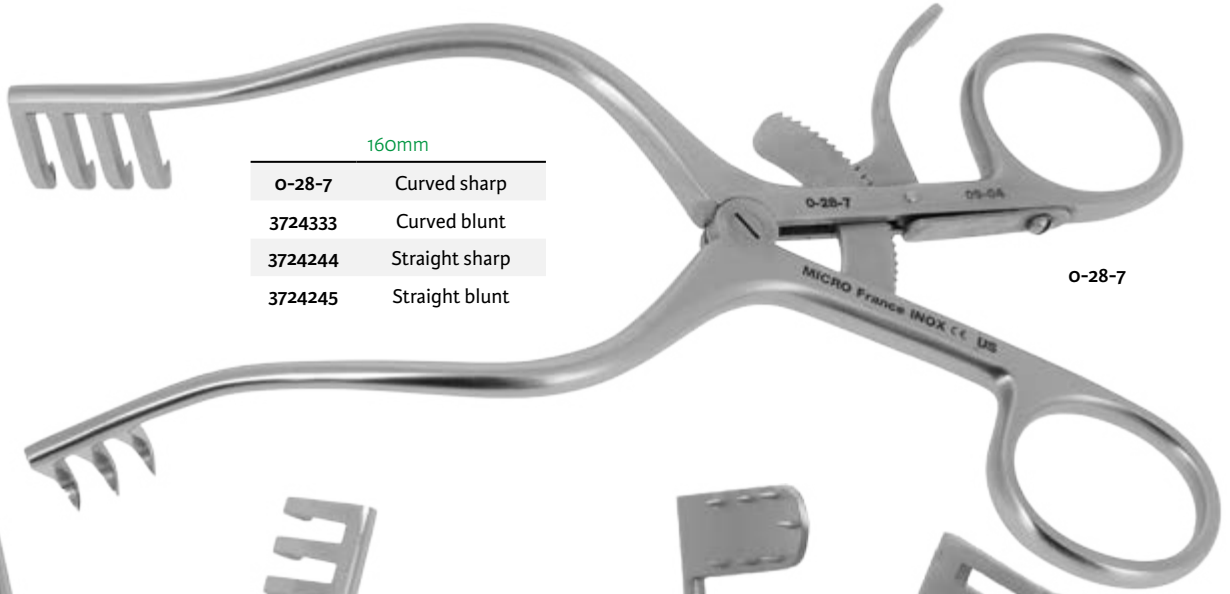

160mm

0-28-7	Curved sharp
3724333	Curved blunt
3724244	Straight sharp
3724245	Straight blunt

0-28-7

**Weitlaner-Beckmann**



165mm

7781
------

**House**

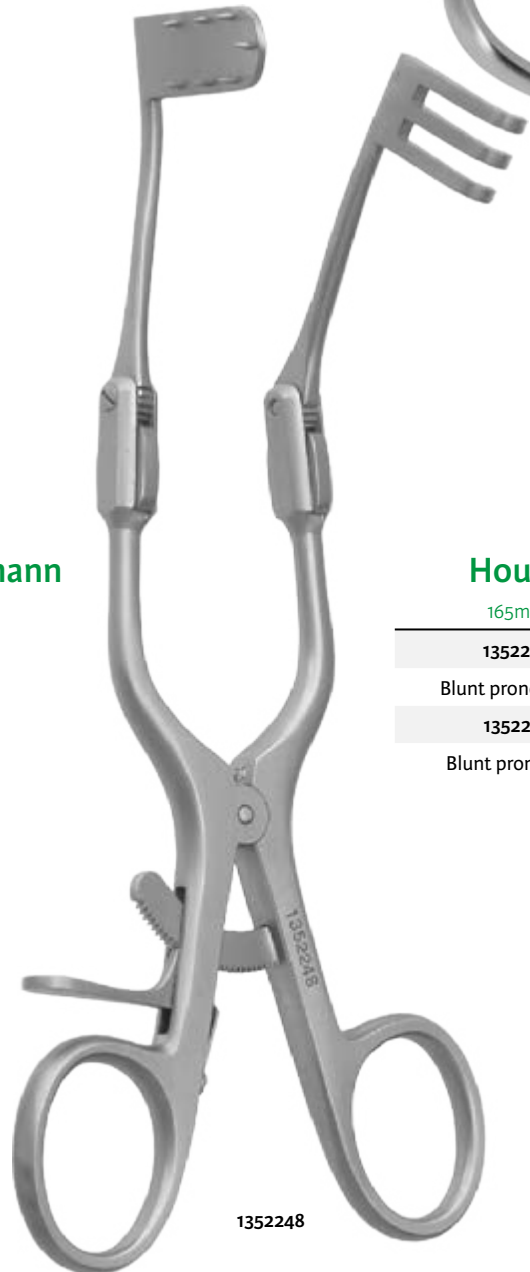

165mm

1352248
Blunt prongs right
1352247
Blunt prongs left

1352248



Endaural curette 200mm

0	3724043	1,5x3,0mm
0	3724044	2,0x3,5mm
0	3724045	2,5x4,0mm
0	3724046	3,0x4,5mm
0	3724047	4,0x5,5mm

Volkman



160mm

0	CP302-4	4,0mm
0	CP302-5	5,0mm
0	CP302-6	6,0mm
0	CP302-8	8,0mm



**Copper**

180mm - 115g

3714350



**Lombard**

185mm - 330g

7766



180mm

CP907 200g

3714105 2 nylon heads



180mm - 230g

CP300

Jost



180mm

	CP801-7	7,0mm
	CP801-10	10,0mm

Freer



160mm

	3714053	4,0mm
--	---------	-------



150mm

	CP823-5	5,0mm
--	---------	-------



150mm

	CP824-5	5,0mm
--	---------	-------

Fleury



130mm

	MCO214-13-10	1,0mm
	MCO214-13-20	2,0mm
	MCO214-13-40	4,0mm
	MCO214-13-60	6,0mm
	MCO214-13-80	8,0mm



**Lempert**

190mm

3712003	4,0mm
3712002	Straight jaws



**Citelli**

7764

3,0mm



**Friedman**

130mm

3712200	1,5x5,0mm
3712201	Curved jaws

Beyer

Jansen-Middleton



180mm

CP380-3	2,0mm
CP380-5	4,0mm
3712211	5,0mm
<b>Ruskin</b>	
CP380-1	2,0mm Straight jaws



160mm

CP380	2,0mm
CP380-2	Curved jaws



180mm

CP621	4,0x20,0mm
-------	------------



105mm

CP353

**Offret**

105mm

CP356



**Streiff**

105mm

CP16-1 Curved blades

CP16 Straight blades



**Joseph**

120mm

CP354A Curved blades

CP354 Straight blades



**Joseph**

110mm

CP919A Curved blades

CP919 Straight blades



**Fox**

110mm

CP358A Curved blades

CP358 Straight blades





Shea

120mm

CP637

Curved blades



Stevens

115mm

CP922B

Curved blades



Bregeat

110mm

CP363

Curved blades



Stevens

110mm

CP922A

Curved blades

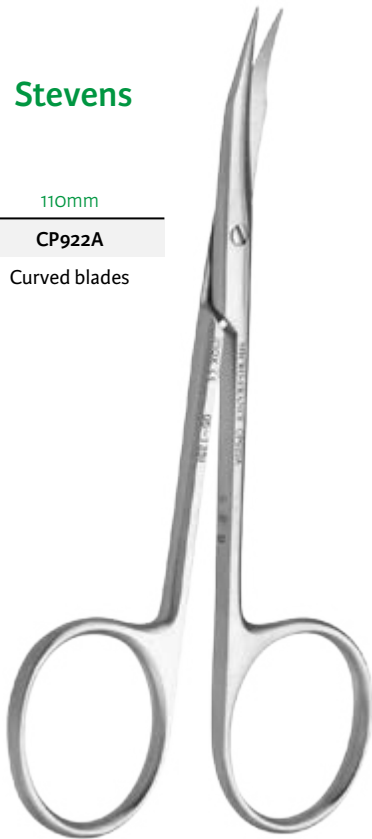

Stevens

110mm

CP922

Straight blades



**Metzenbaum**

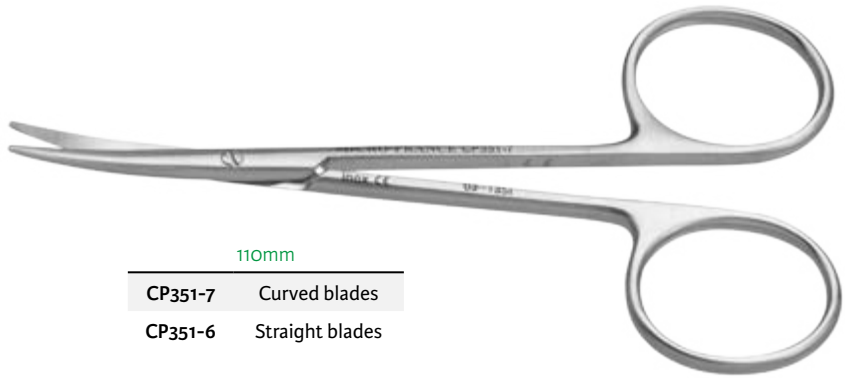

110mm

CP351-7	Curved blades
CP351-6	Straight blades

**Fine blades**



150mm

CP931-1	Curved blades
CP931	Straight blades

**Tungsten blades**



150mm

CP351-3	Curved blades
CP351-2	Straight blades



150mm

3741065	Curved blades
3741071	Fine model

Mayo



CP352-1



CP352-3



3741057



3741080

Mayo-Stillle

Mayo	150mm	170mm
Curved blades	CP352-1	CP352-3
Straight blades	CP352	CP352-2

150mm
3741057
Scissors, straight pointed blades

Mayo-Stillle	150mm	170mm
Curved blades	3741080	3741082
Straight blades	3741081	3741083

Dissecting forceps with teeth and platform



110mm  
**CP37**  
Oblique teeth and platform

110mm  
**CP938-1**  
Horizontal teeth and platform

Castroviejo

Dissecting forceps serrated jaws

Dissecting forceps with teeth

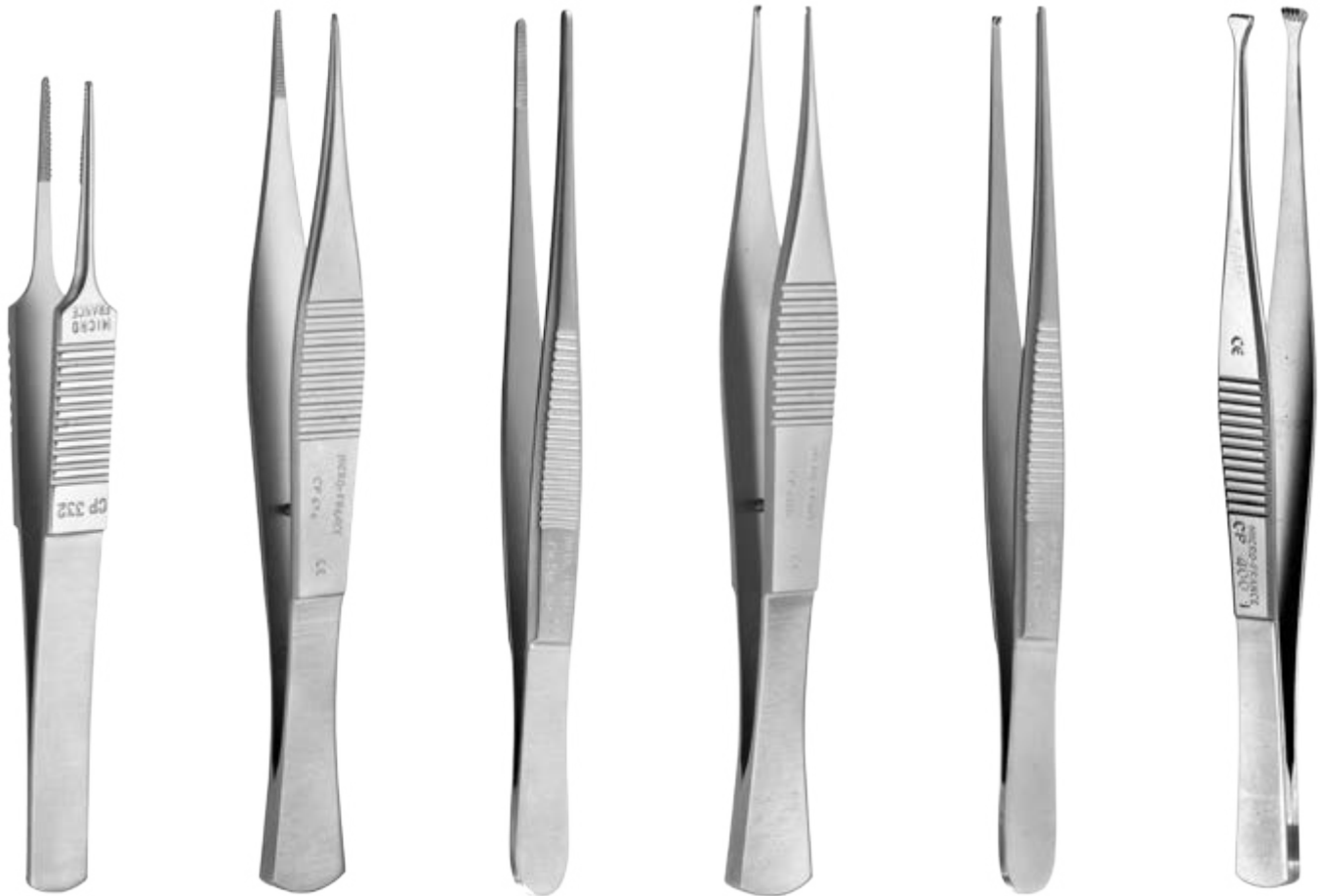

110mm  
**CP332**

120mm  
**CP414**  
Jaws 1,0mm

120mm  
**7831A-12**  
Jaws 1,5mm

120mm  
**CP406**  
Jaws 1,0mm

120mm  
**7833A-12**  
Jaws 1,5mm

120mm  
**CP400-1**  
Jaws 5x5

150mm

Adson



CP604-15  
Jaws 1,5mm  
Serrated jaws

Adson



CP605-15  
Jaws 1,5mm  
With teeth

Adson-Brown



CP606-15  
Jaws 7x7

120mm



Adson-Tubiana

Adson

Adson-Brown

<b>M832</b>	<b>M833</b>	<b>CP604</b>	<b>CP605</b>	<b>3740027</b>	<b>CP606A</b>	<b>CP606</b>	<b>3740038</b>
Jaws 1,0mm Serrated jaws	Jaws 1,0mm with teeth	Jaws 1,5mm Serrated jaws	Jaws 1,5mm with teeth	Jaws 1,0mm Serrated jaws with teeth	Jaws 1,5mm Tungsten jaws	Jaws 7x7	Jaws 7x7 Angled jaws

Mac-Indoe



140mm

CP934

Oblique teeth

Mac-Indoe

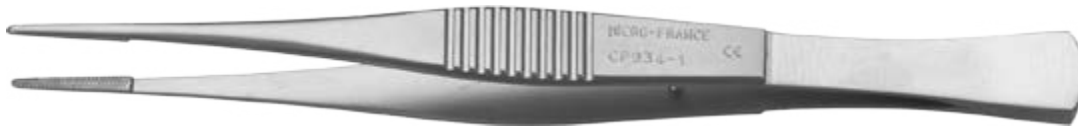

140mm

CP934-1

Serrated jaws

Debakey

Barraya

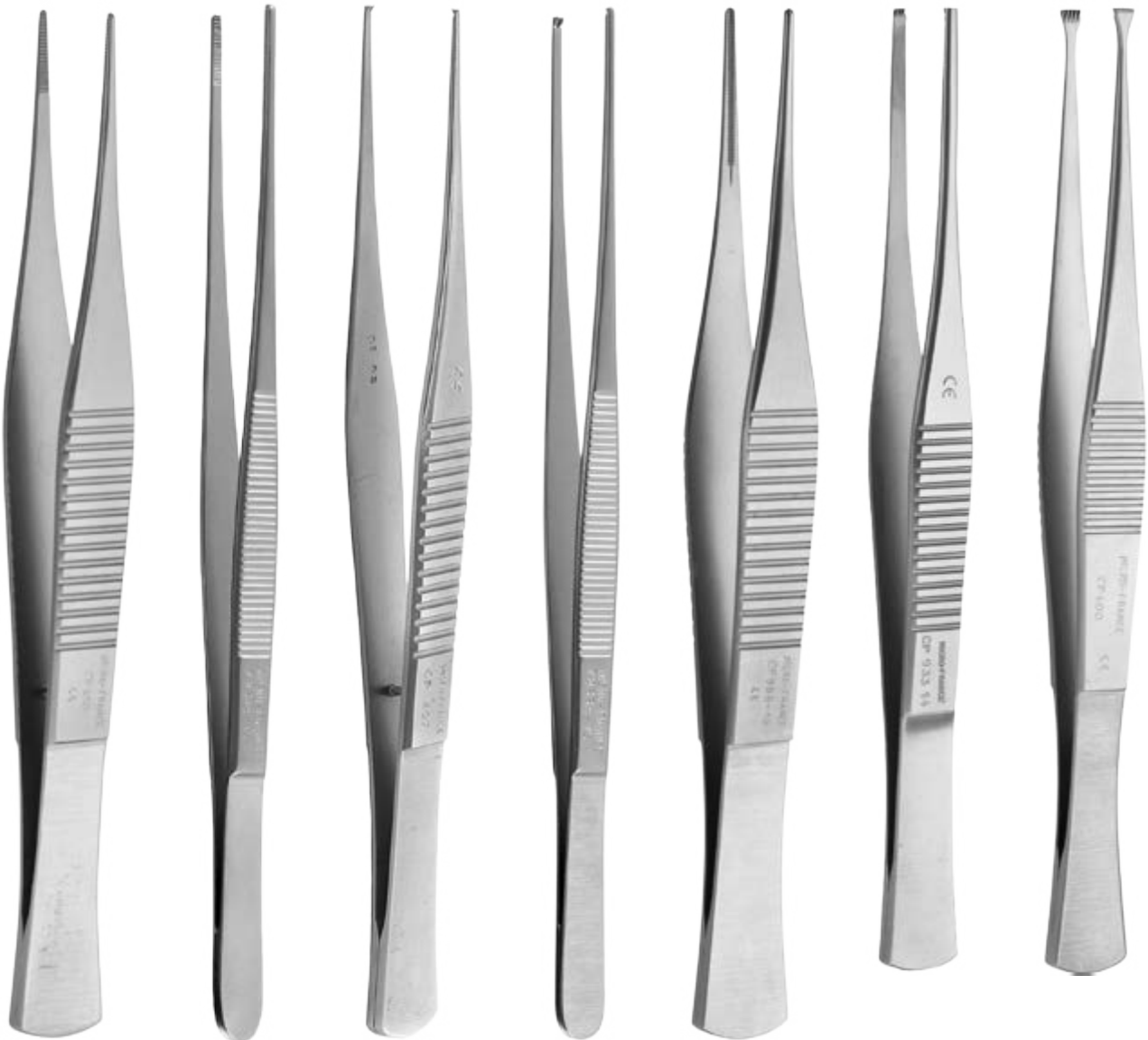

150mm

140mm

CP415	7831A-15	CP407	7833A-15	CP988-15	CP933-14	CP400
Jaws 1,0mm	Jaws 1,5mm	Jaws 1,0mm	Jaws 1,5mm	Jaws 1,5mm	Jaws 3x4	Jaws 5x5

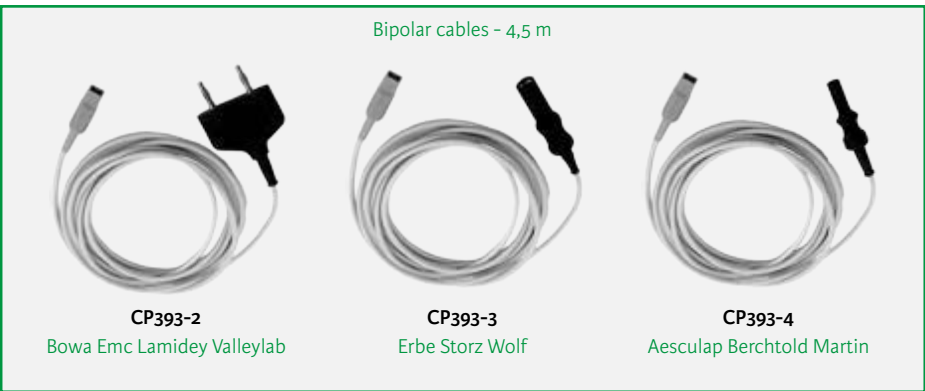

**Magnan**

**Adson**



110mm	120mm		160mm		200mm	
<b>CP392-1R</b>	<b>CP604BR</b>	<b>CP605BR</b>	<b>CP392-2R</b>	<b>CP392-8R</b>	<b>CP392BI</b>	<b>CP392BS</b>
Jaws 1x8mm	Serrated jaws	Jaws with teeth	Jaws 1x8mm	Jaws 1x8mm	Jaws 0,5x5mm	Jaws 0,5x5mm





**Adson**



110mm

**CP390-1**

Jaws 1x8mm



120mm

**CP604M**

Serrated jaws



**CP605M**

Jaws with teeth



160mm

**CP390-2**

Jaws 1x8mm



**CP390-8**

Jaws with teeth



**Halsey**

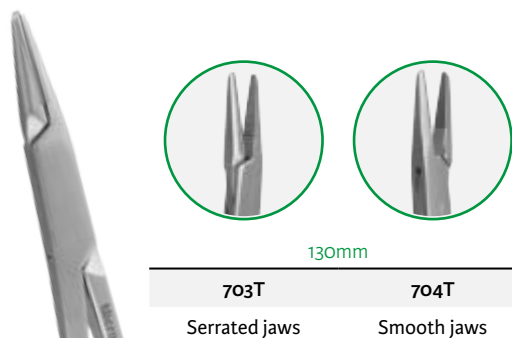

**Ryder**

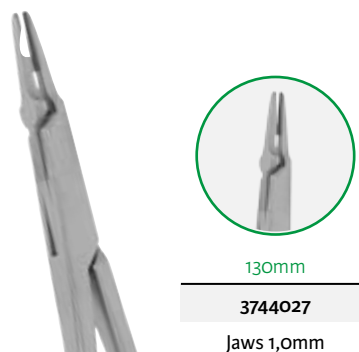

**Crile-Wood**

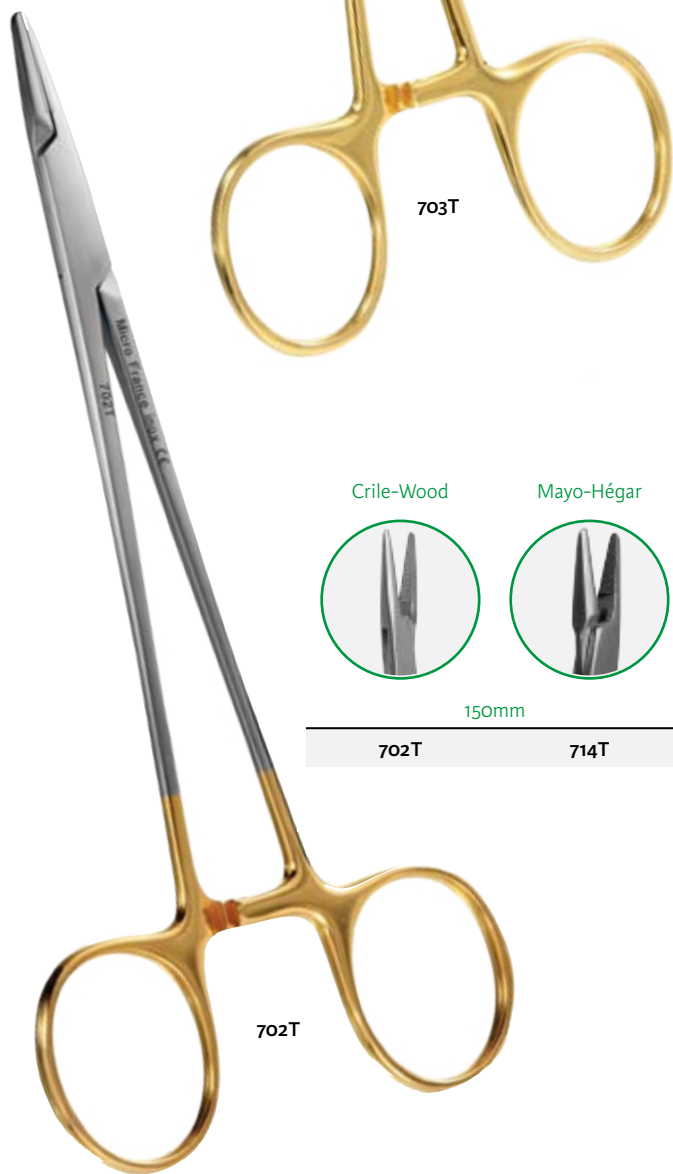

**Becker**



**Hartmann-Mosquito**

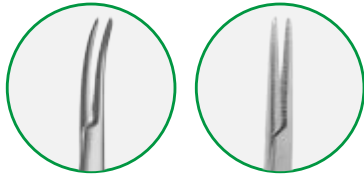

95mm

**3755111**

**3755110**

Curved

Straight

Without teeth

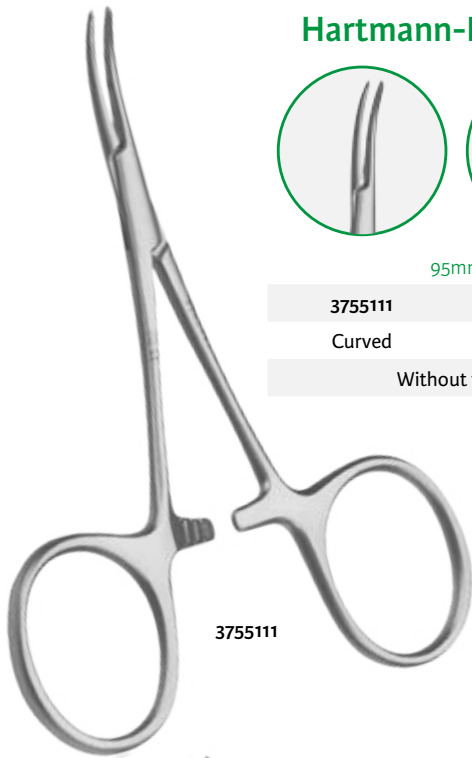

3755111

**Halsted-Mosquito**

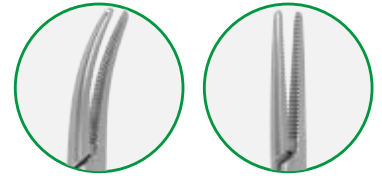

120mm

**3755102**

**3755101**

Curved

Straight

Without teeth

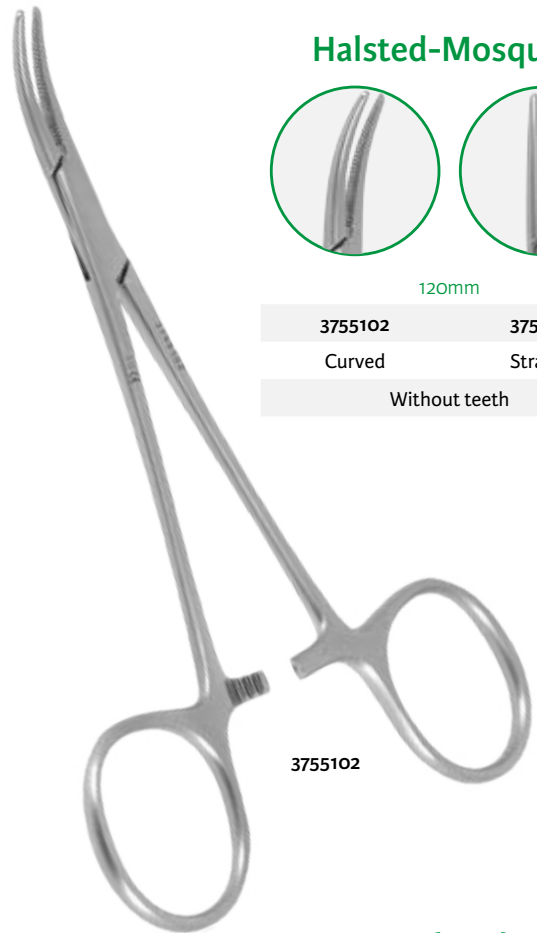

3755102

**Leriche**

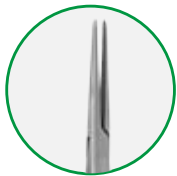

140mm

**7867-1**

Straight

Without teeth

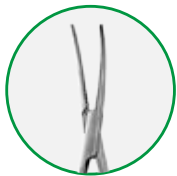

140mm

**7867-2**

Curved

Without teeth

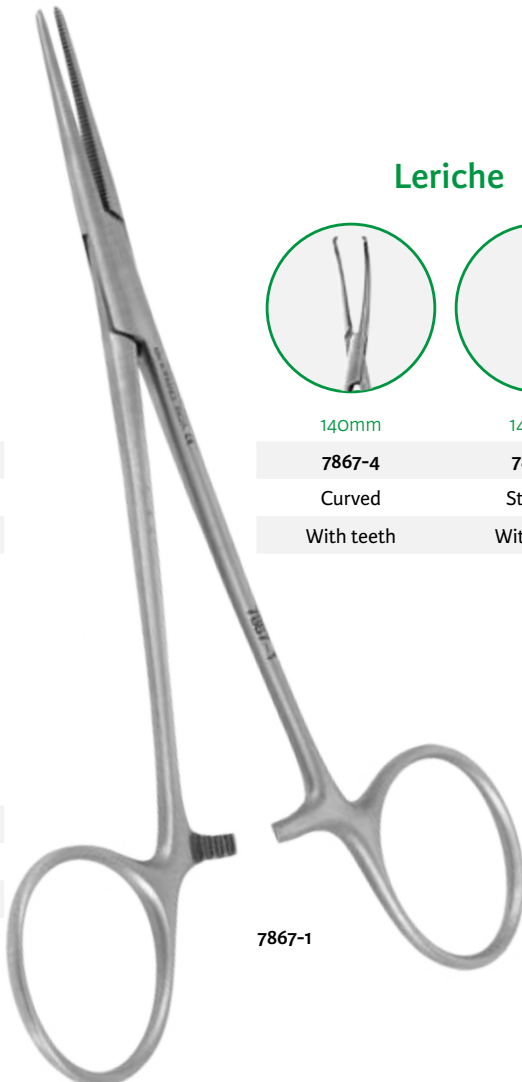

7867-1

**Leriche**

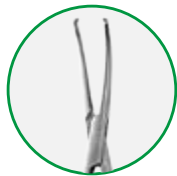

140mm

**7867-4**

Curved

With teeth

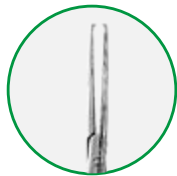

140mm

**7867-3**

Straight

With teeth

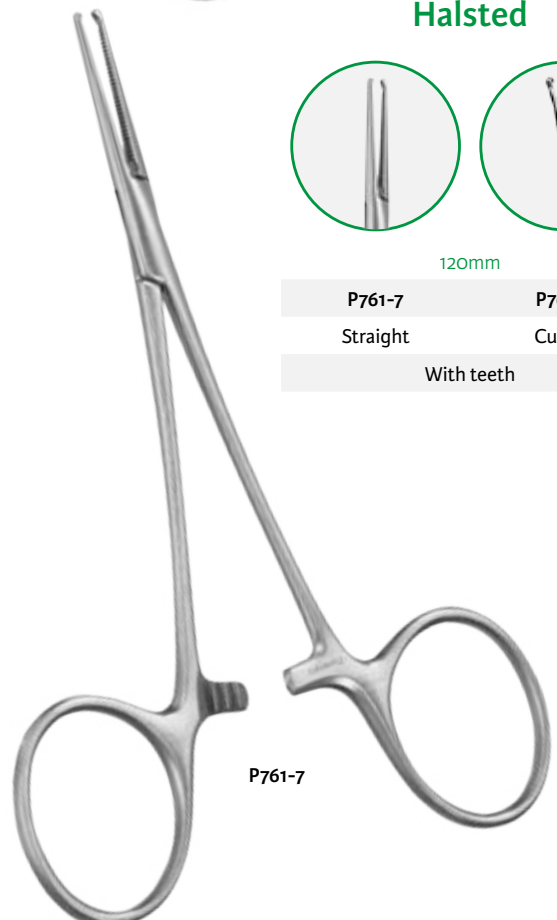

P761-7

**Halsted**

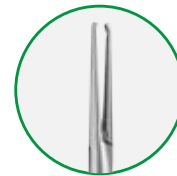

120mm

**P761-7**

Straight

With teeth



**P761-8**

Curved

**Crile**

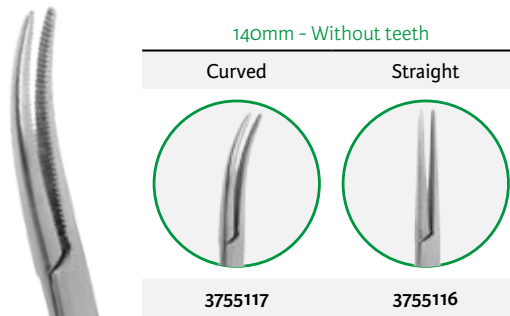

**Kelly**

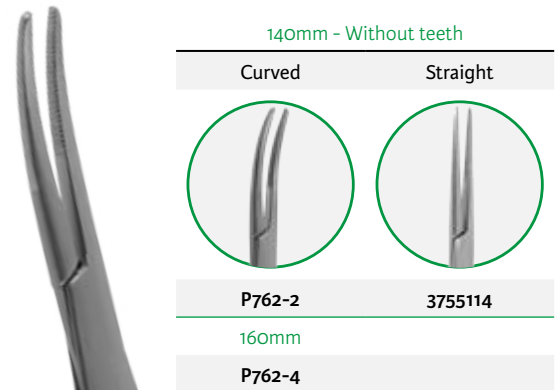

**Rochester-Péan**

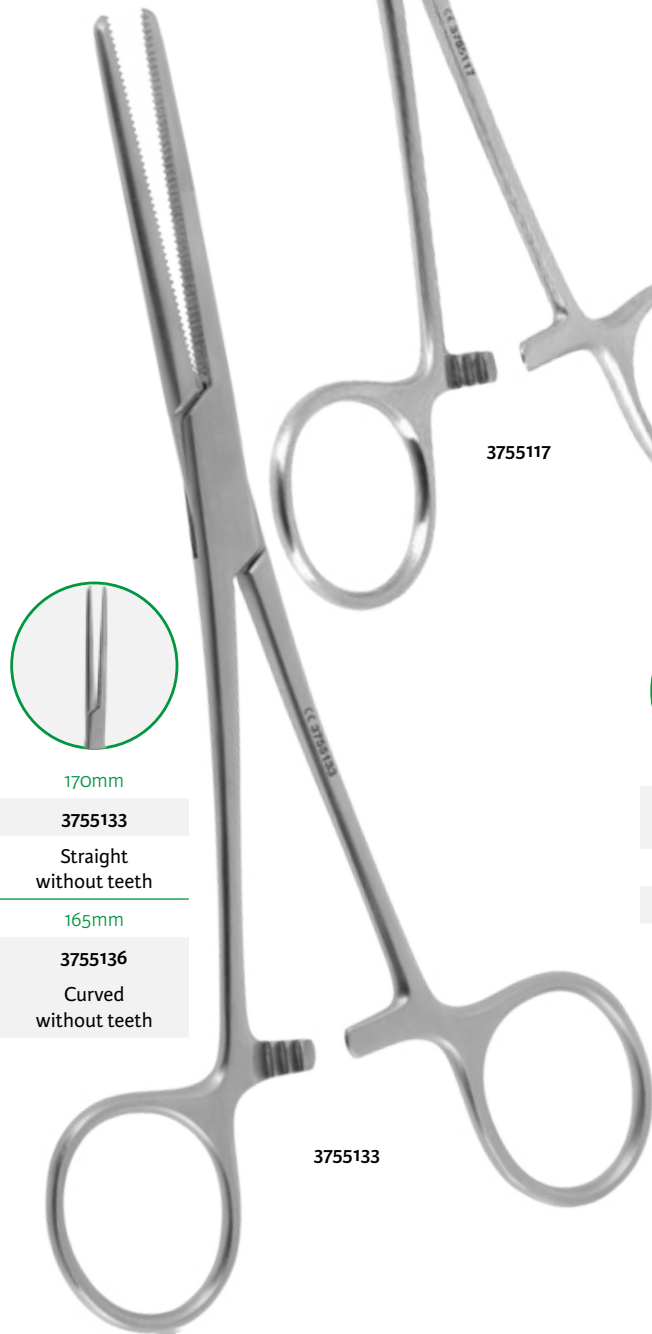

**Kocher**

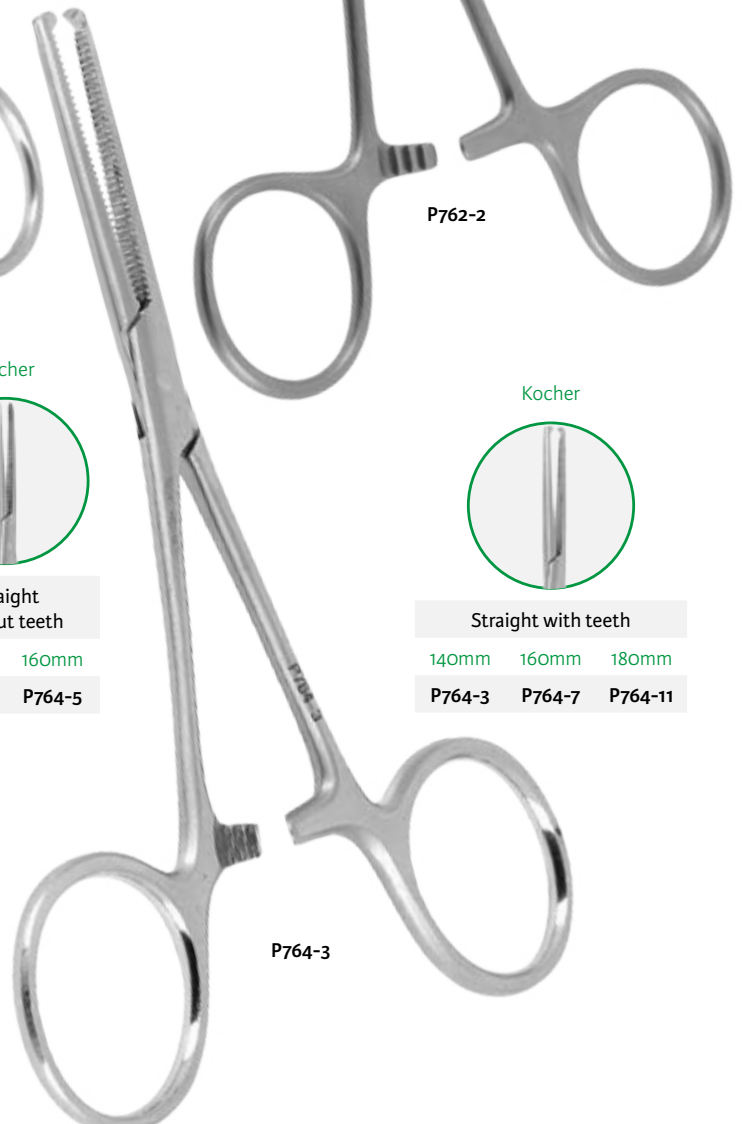
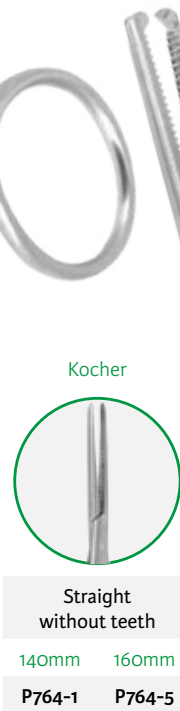

**Backauss**

Towel clamp

90mm

3755000

120mm

3755001

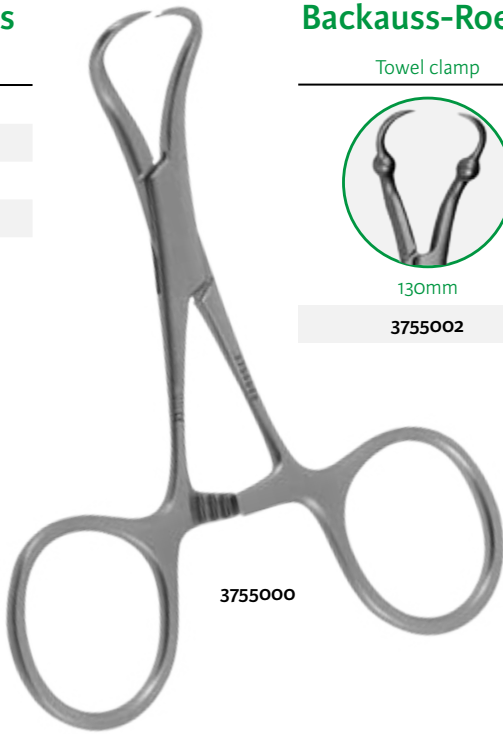

3755000

**Backauss-Roeder**

Towel clamp



130mm

3755002

**Martel**

Forceps with teeth  
"T" tip



130mm

P763



P763

**Péan**

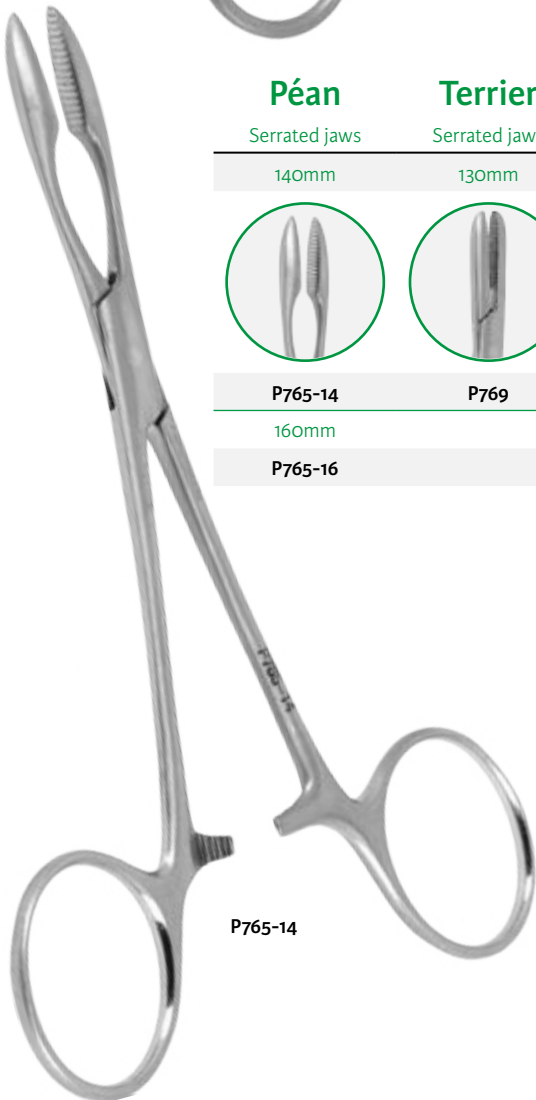

P765-14

**Péan**

Serrated jaws

140mm

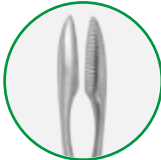

P765-14

160mm

P765-16

**Terrier**

Serrated jaws

130mm

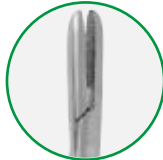

P769

**Chaput**

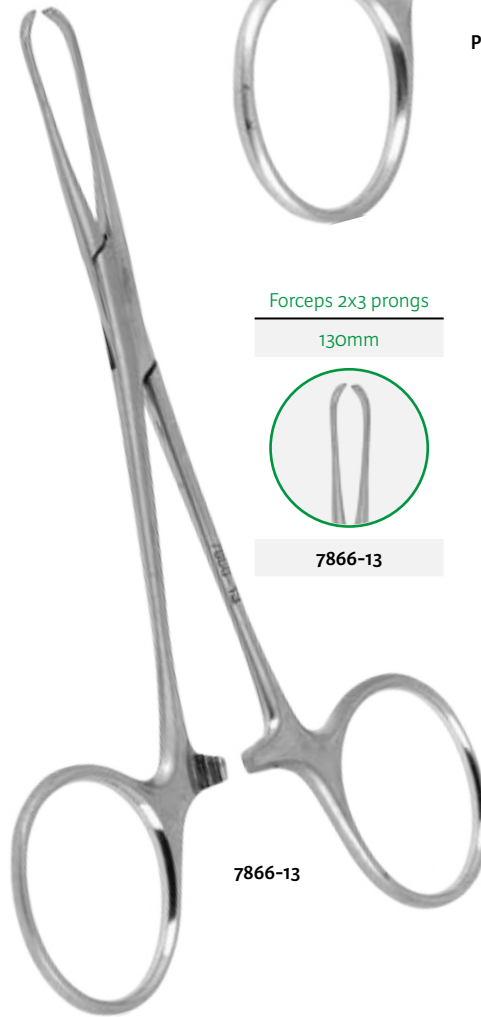

7866-13

Forceps 2x3 prongs

130mm

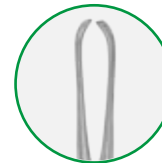

7866-13

**Allis**

Forceps with teeth

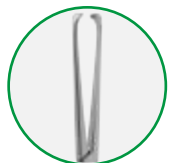

3755161

150mm  
4x5 prongs

3755160

140mm  
3x4 prongs

3755162

150mm  
5x6 prongs

Wertheimer

Jankowski

Lempert

○ 1,5mm

○ 2,0mm

○ 2,5mm

○ 3,0mm

○ 3,5mm

○ 4,0mm



Working length 120mm

MCO770-3-5	3,5mm
MCO770-1-5	1,5mm
MCO770-2-0	2,0mm
MCO770-2-5	2,5mm
MCO770-3-0	3,0mm
MCO770-3-5	3,5mm
MCO770-4-0	4,0mm



Working length 120mm

MCEN770J40	4,0mm
MCEN770J30	3,0mm



Working length 120mm

MCO771-2-5	2,5mm
MCO771-3-0	3,0mm
MCO771-4-0	4,0mm



Working length 110mm

CP330-3-0	3,0mm
CP330-4-0	4,0mm

Luer-lock US adapter

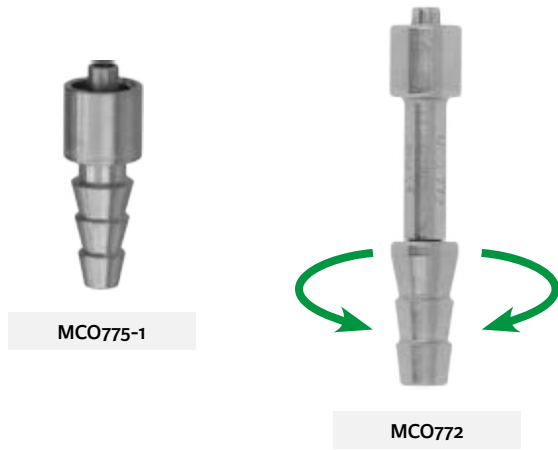

Suction tube adapter with finger control



Curved and angled suction tube

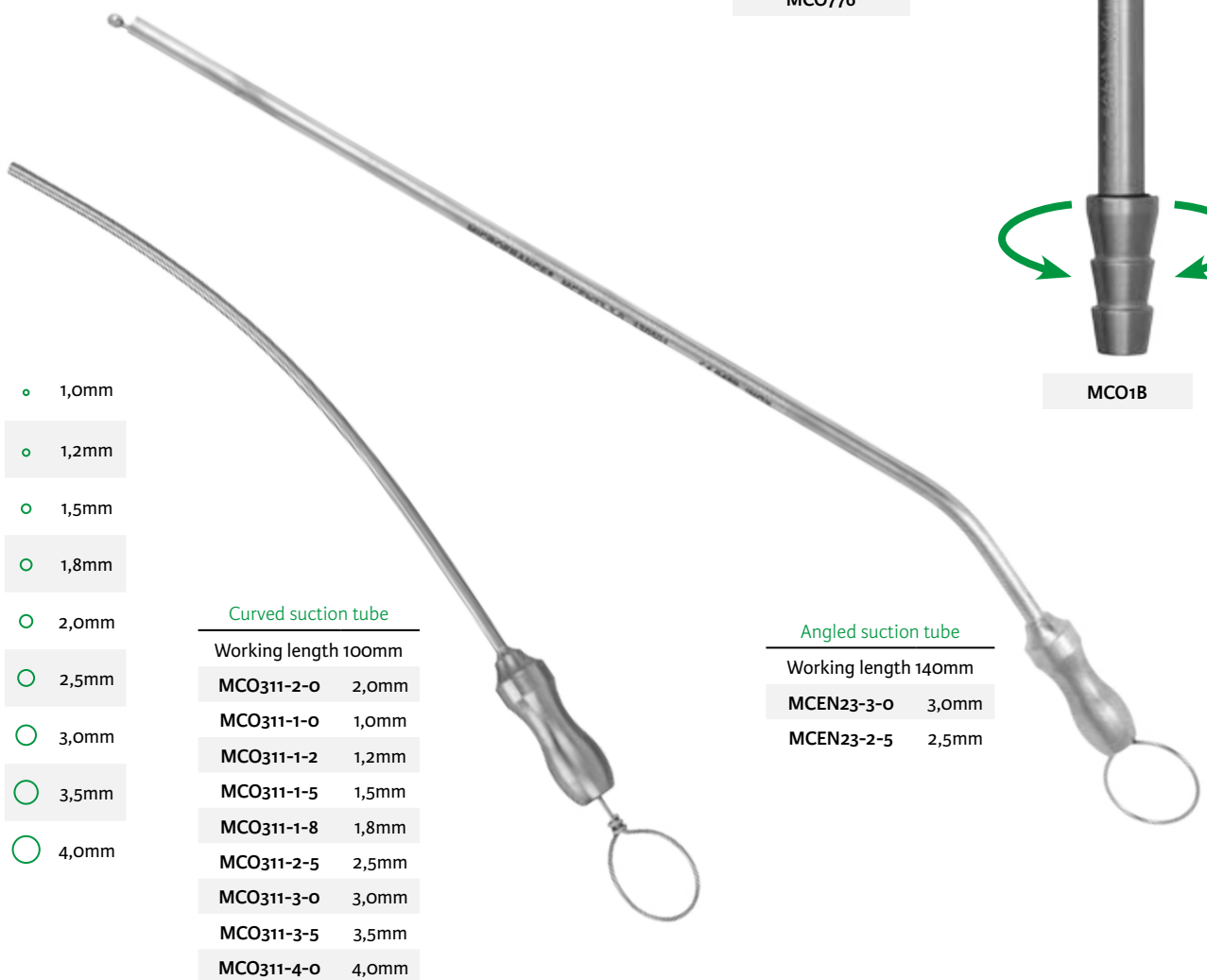

- 1,0mm
- 1,2mm
- 1,5mm
- 1,8mm
- 2,0mm
- 2,5mm
- 3,0mm
- 3,5mm
- 4,0mm

Curved suction tube

Working length 100mm	
MCO311-2-0	2,0mm
MCO311-1-0	1,0mm
MCO311-1-2	1,2mm
MCO311-1-5	1,5mm
MCO311-1-8	1,8mm
MCO311-2-5	2,5mm
MCO311-3-0	3,0mm
MCO311-3-5	3,5mm
MCO311-4-0	4,0mm

Angled suction tube

Working length 140mm	
MCEN23-3-0	3,0mm
MCEN23-2-5	2,5mm

**Suction irrigation tube with finger control**

MCO201-2-5	2,5mm
MCO201-3-0	3,0mm
MCO201-4-0	4,0mm

**Maspetiol**  
Micro MCO774-0-5

**Charachon**  
Micro MCO890-1-12

**Mac-Gee**

**Barnes**

- 0,4mm
- 0,5mm
- 0,6mm
- 0,7mm
- 0,8mm
- 1,0mm
- 1,2mm
- 1,4mm
- 1,5mm
- 1,7mm
- 1,8mm
- 2,0mm
- 2,4mm
- 2,5mm
- 3,0mm

Suction tube with luer-lock connection	
<b>MCO773</b>	
Suction tube for MCO773	
MCO774-0-4	0,4mm
MCO774-0-5	0,5mm
MCO774-0-6	0,6mm
MCO774D8	0,8mm

Suction tube with finger control for MCO890-1	
<b>MCO890</b>	
Suction tube for MCO890	
MCO890-1-04	0,4mm
MCO890-1-08	0,8mm
MCO890-1-12	1,2mm
MCO890-1-15	1,5mm
MCO890-1-20	2,0mm

Curved suction tube	
<b>3724420</b>	
0,7mm	
<b>3724421</b>	
0,5mm	
<b>3724422</b>	
0,4mm	

Curved suction tube with finger control	
<b>3724185</b>	
2,0mm	
<b>3724183</b>	
1,4mm	
<b>3724184</b>	
1,7mm	



Frasse

Cause

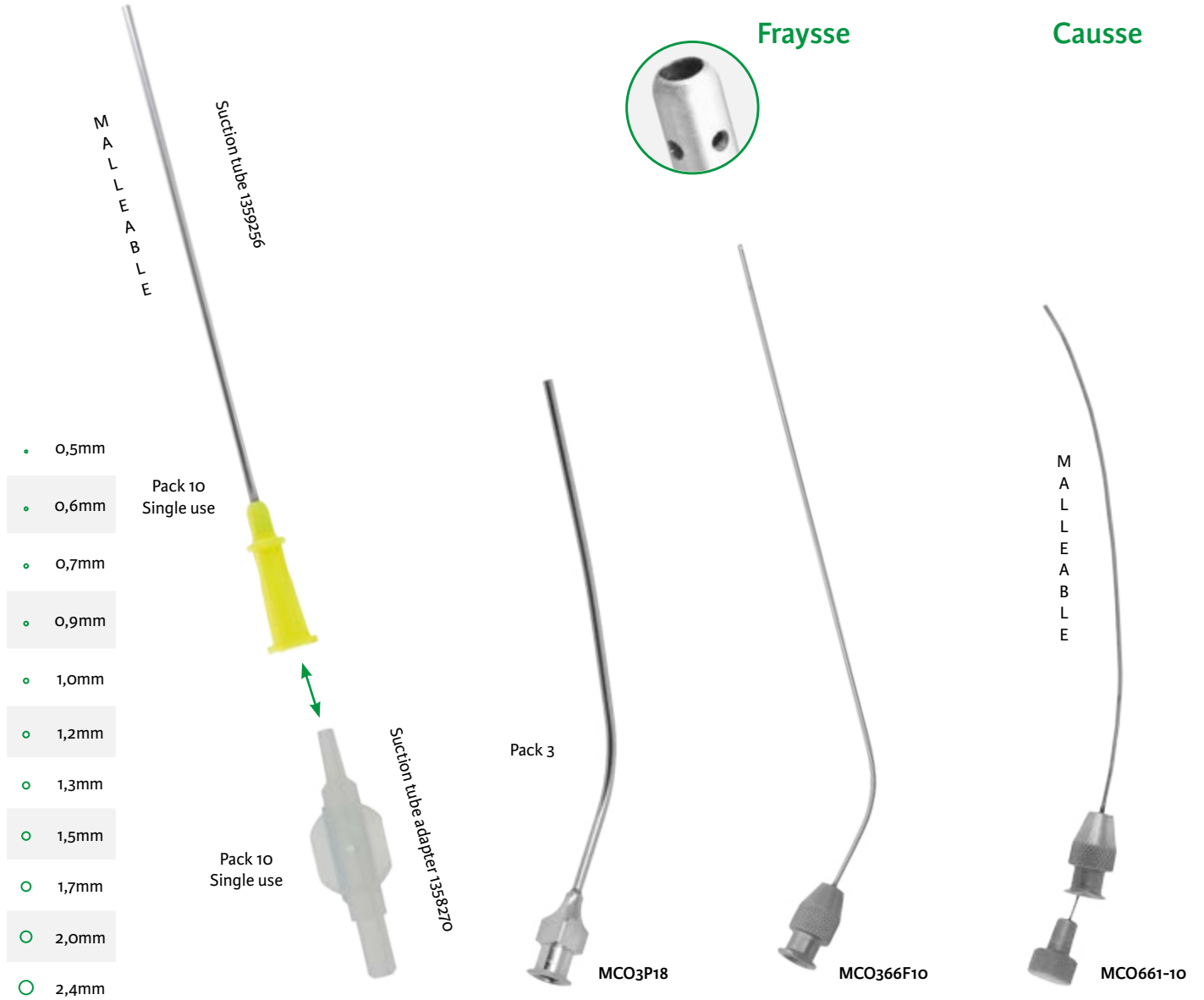

MicroLite® suction tube adapter with finger control

Sterile - Pack 10 - Single use		
1358270		

MicroLite® malleable suction tube with luer-lock for 1358270

Sterile - Pack 10 - Single use		
1359254	red	2,1mm
1359256	yellow	1,6mm
1359258	black	1,3mm
1359260	green	0,9mm
1359262	clear	0,7mm
1359264	blue	0,5mm

Angled suction tube with luer-lock

Pack 3	
MCO3P05	0,5mm
MCO3P07	0,7mm
MCO3P10	1,0mm
MCO3P12	1,2mm
MCO3P15	1,5mm
MCO3P18	1,8mm
MCO3P20	2,0mm
MCO3P24	2,4mm

Blunt eyes suction tube with luer-lock connection

MCO366F10	1,0mm
MCO366F12	1,2mm
MCO366F15	1,5mm
MCO366F20	2,0mm

Malleable suction tube with luer-lock connection

MCO661-10	1,0mm
MCO661-7	0,7mm







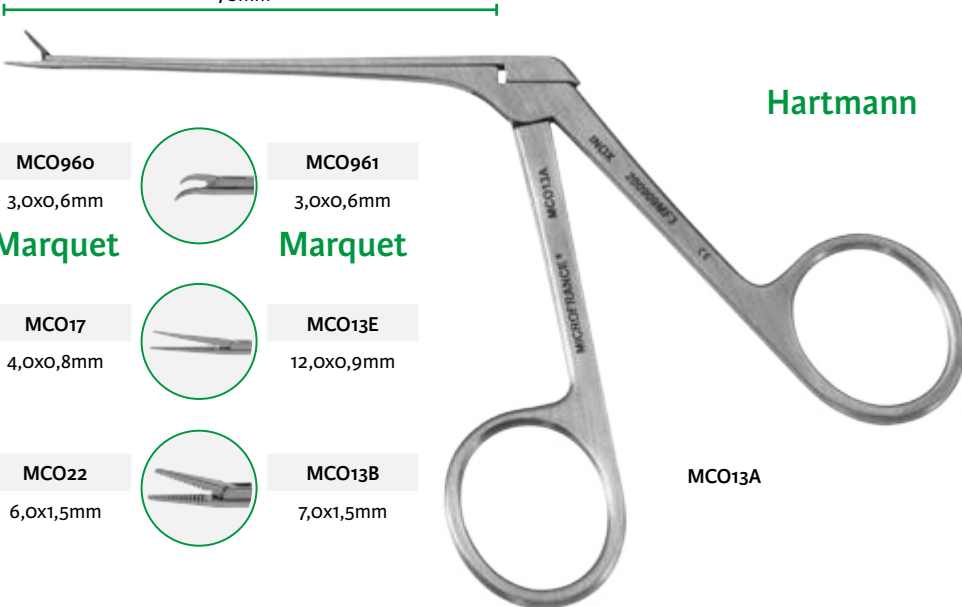

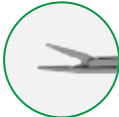

Forceps serrated jaws

70mm



**Hartmann**

 <b>MCO13C</b> 3,0x0,6mm	 <b>MCO960</b> 3,0x0,6mm	 <b>MCO961</b> 3,0x0,6mm
 <b>MCO13A</b> 4,0x0,8mm	 <b>MCO17</b> 4,0x0,8mm	 <b>MCO13E</b> 12,0x0,9mm
 <b>MCO13D</b> 5,0x1,0mm	 <b>MCO22</b> 6,0x1,5mm	 <b>MCO13B</b> 7,0x1,5mm

**Marquet**                      **Marquet**

MCO13A

Alligator forceps

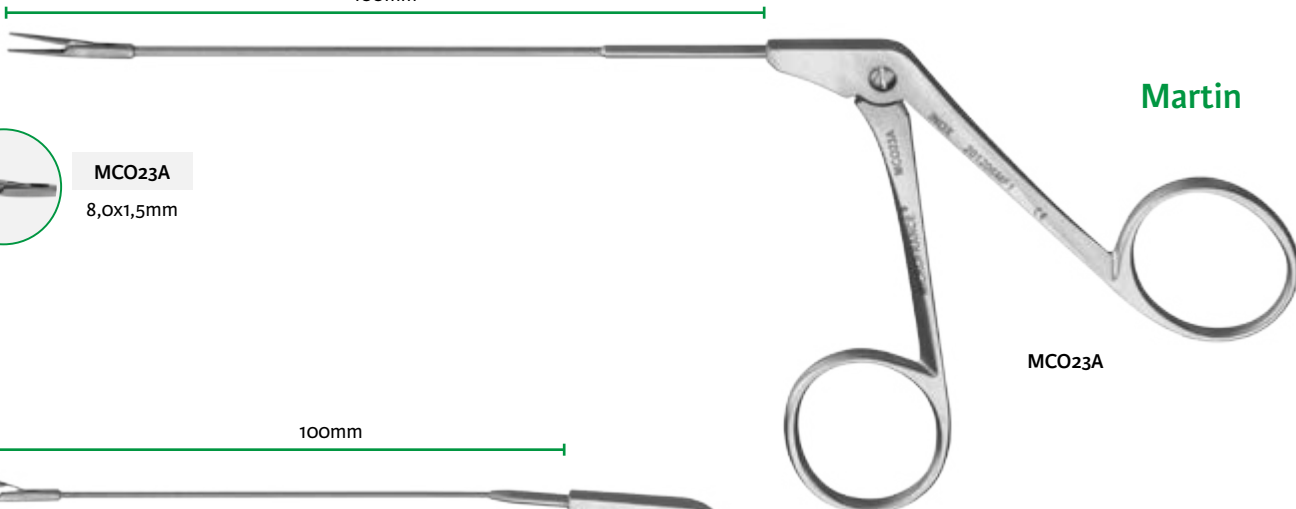

100mm



**Martin**

MCO23A

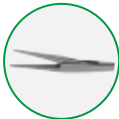
100mm

 <b>MCO23A</b> 8,0x1,5mm
 <b>MCO23</b> 6,0x1,0mm
 <b>MCO23B</b> 6,0x1,0mm right opening

MCO23

Micro scissors

Wiet

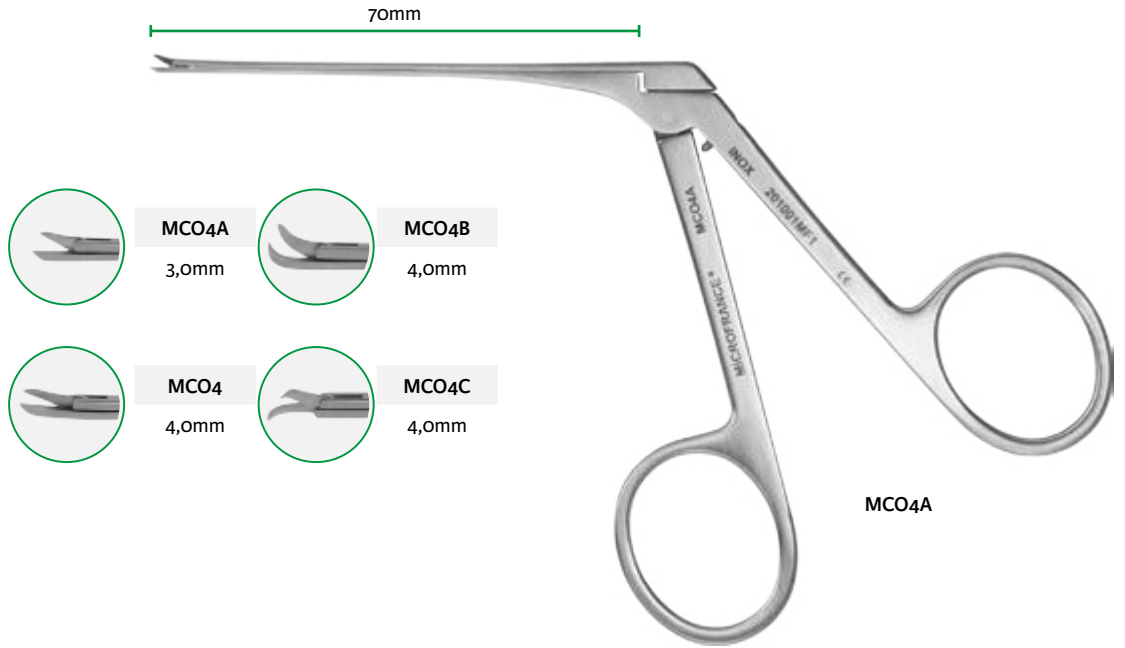

Micro cup forceps

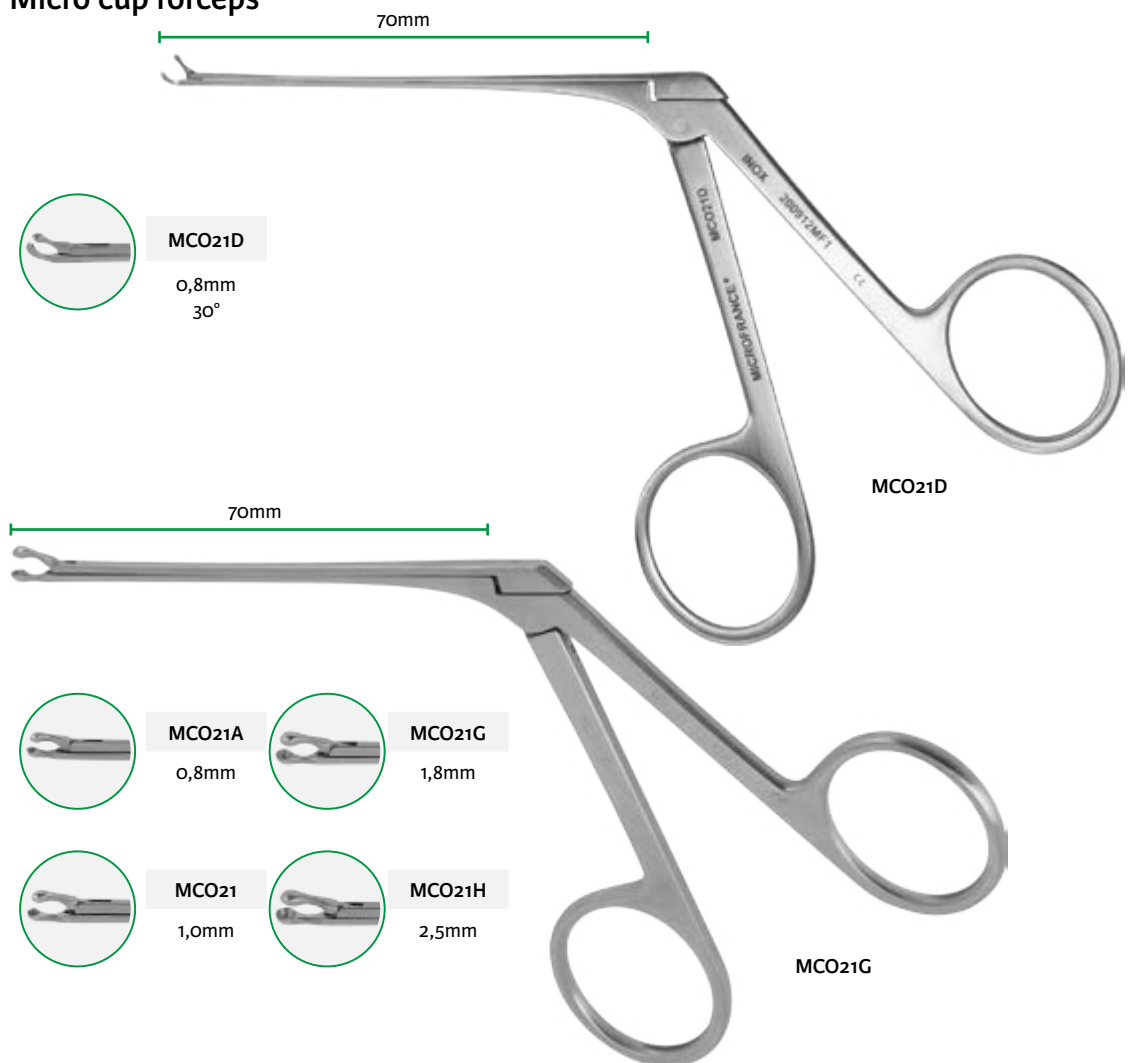

Microcut forceps

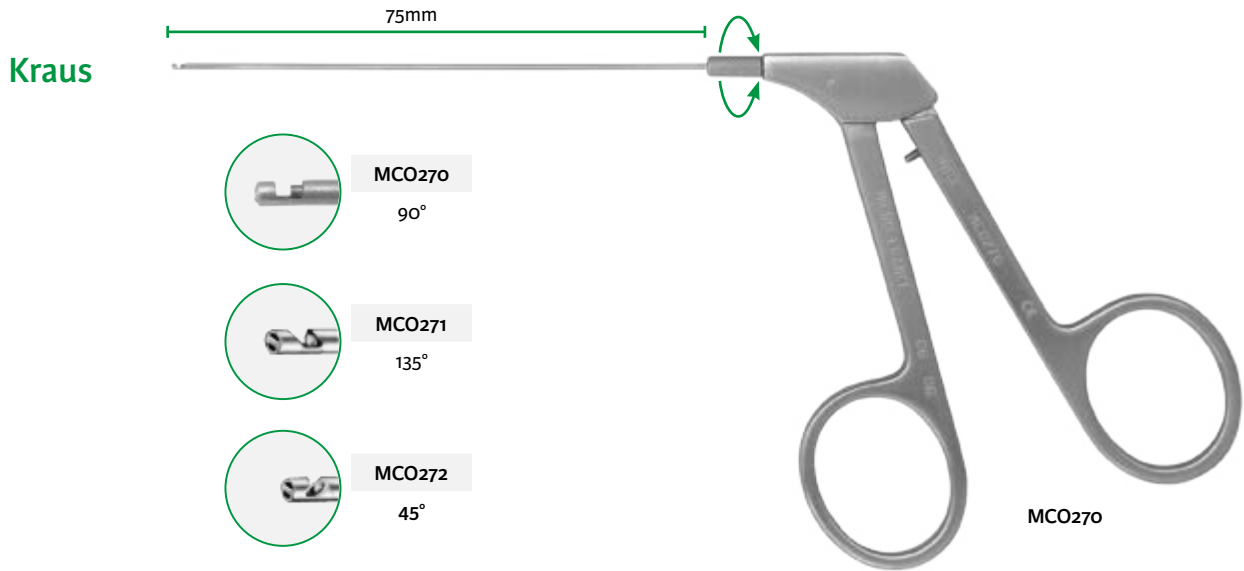

Malleus nipper forceps

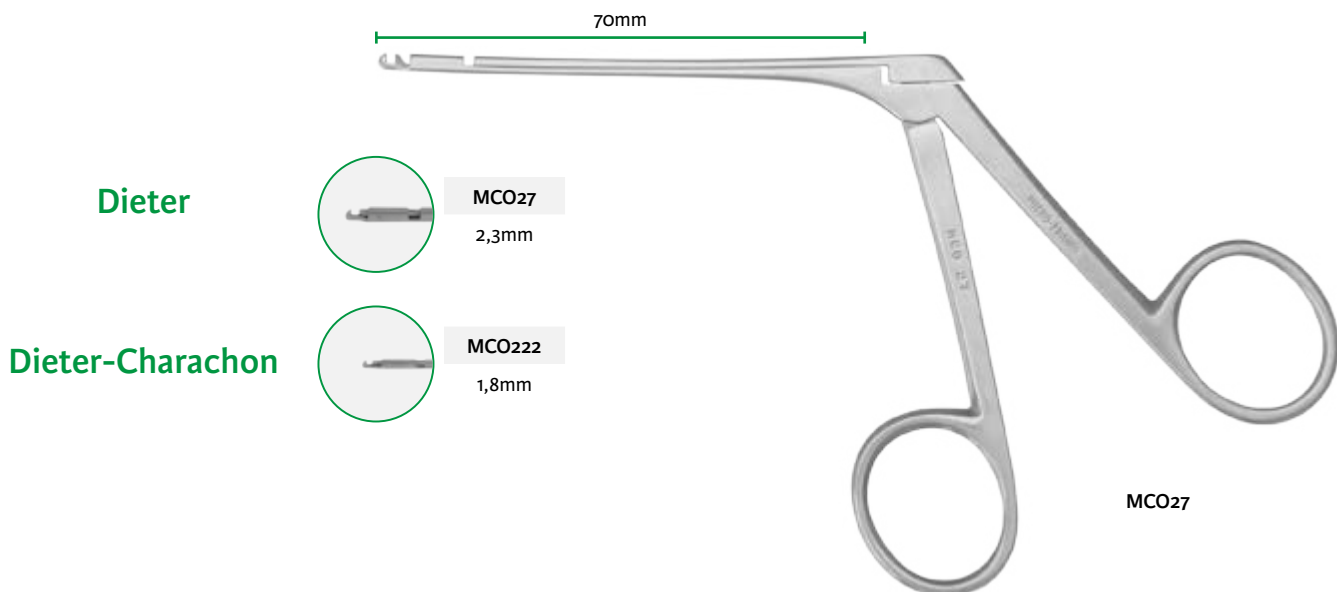

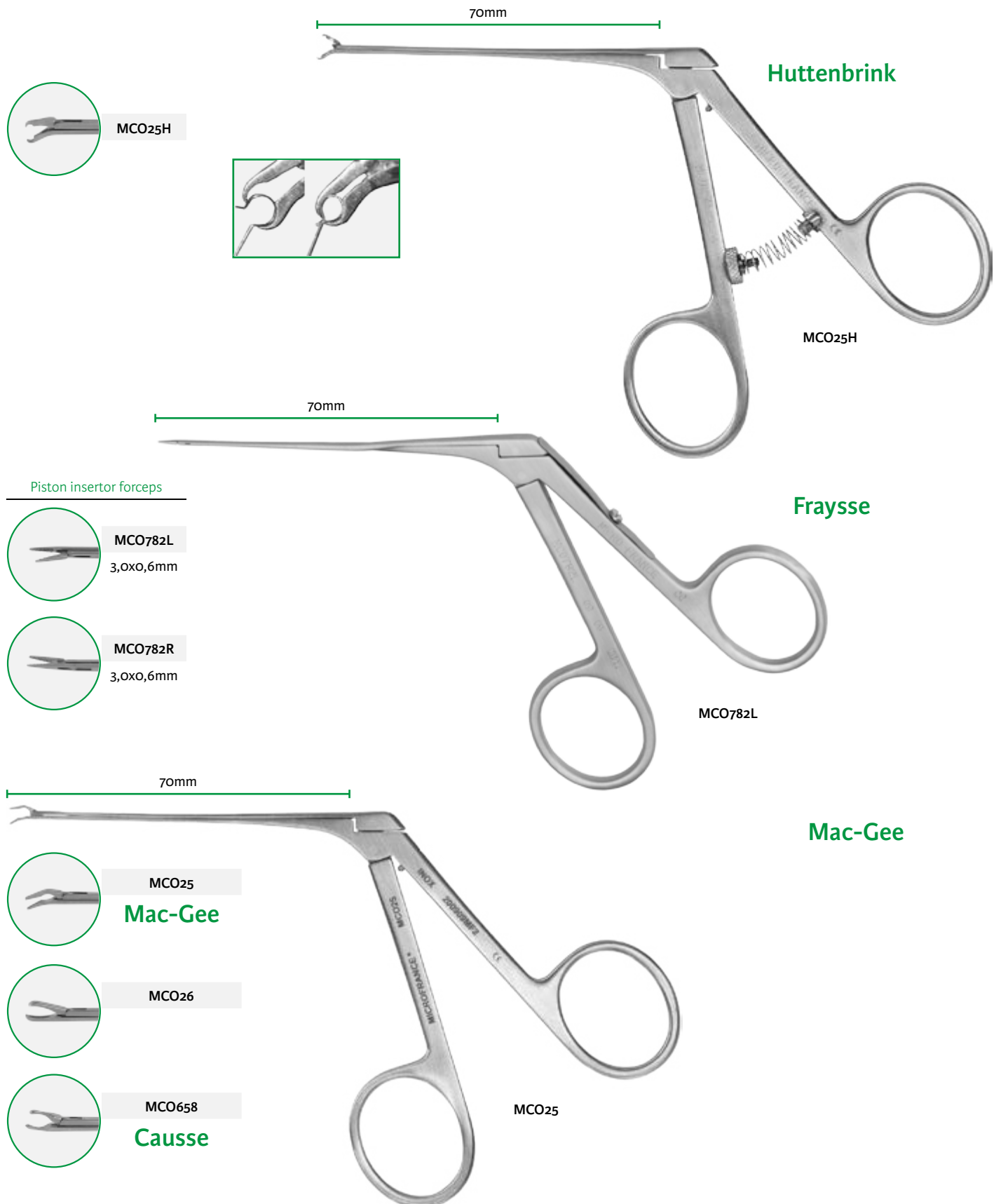



MCO5A-2-5  
165mm



Knife							Lancet knife					
45°	Causse		45°	Martin		45°	45°	Rosen	45°	Plester	Causse	45°
MCO5A-2-5	2,5mm	MCO652	3,0mm	MCO215	3,0mm	MCO5C	2,5mm	MCO313		MCO6		MCO653
MCO5A-1-0	1,0mm			Knife mirror		angled tip		1,8x2,5mm		2,0x2,5mm		1,5x2,0mm
MCO5A-1-5	1,5mm											3724293
MCO5A-2-0	2,0mm											2,0x3,0mm
Sickle knife							Lancet knife				Chisel	



MCO10

**Morgon**



MCO10M

**Jost**

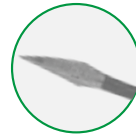

MCO204C

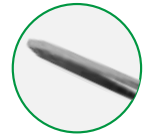

3722009

0,6mm



MCO650  
165mm



Tige coudée



MCO5B  
30°  
2,5mm

**Causse**

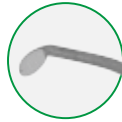

MCO650  
90°  
3,0mm



MCO5  
90°  
2,5mm

Knife

**Frayse**

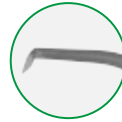

MCO651F  
90°

**Causse**

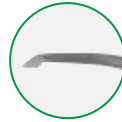

MCO651  
45°

Lancet knife

**Plester**



MCO6C  
30°  
2,0x2,5mm

Oval knife



MCO5E  
165mm

Aspiration



MCO5D  
45°  
2,0mm

Suction round knife



MCO5E  
45°  
3,0mm

**Josephson**



MCO312  
160mm



Sickle knife

MCO312

Double knife

Knife  
45° - 1,5x3,0mm



**Micro mirror**

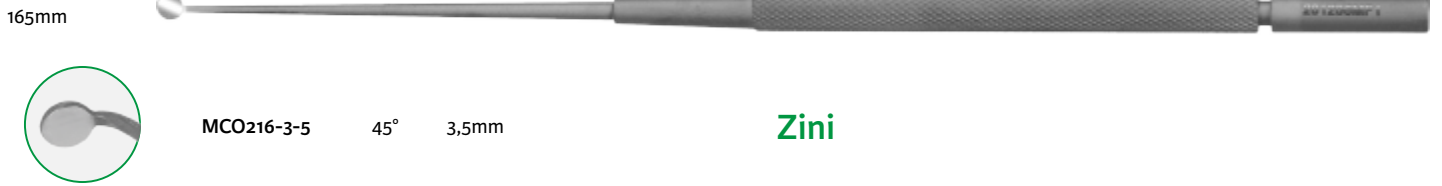

**Micro raspatory**

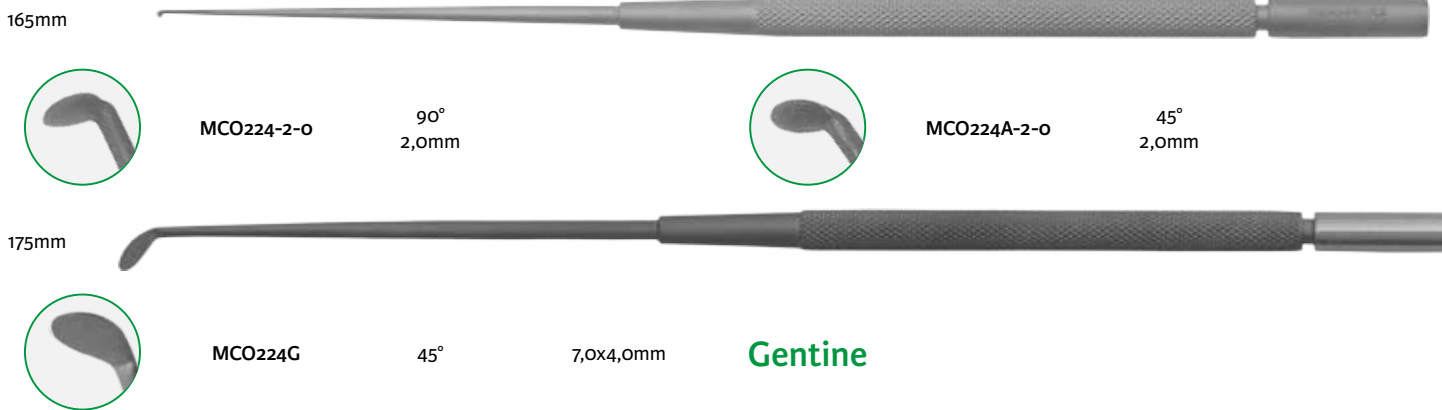

**Whirlybird elevator**

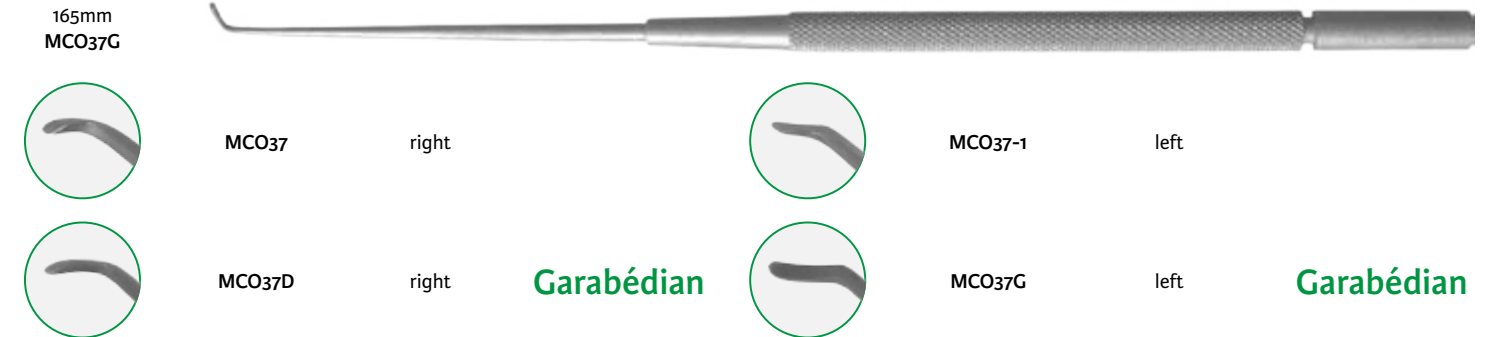

**Curved elevator**

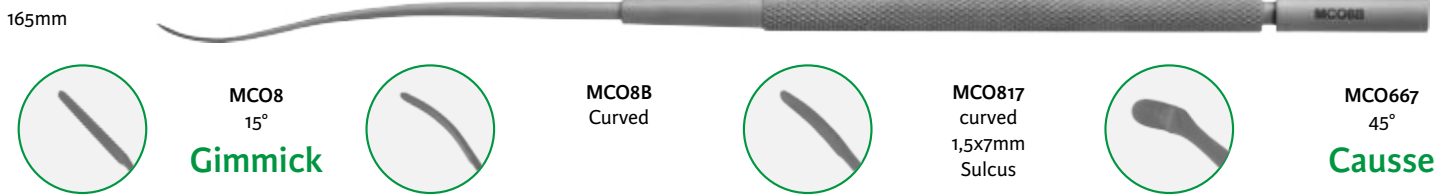

**Double curved elevator**



**Fenestrated curette**



**Micro curette straight**

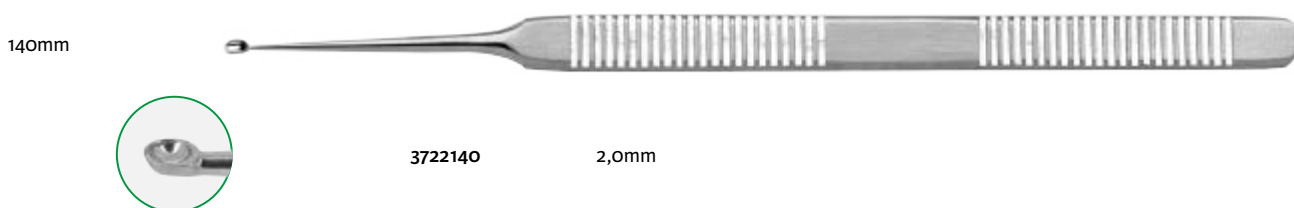

**Micro curette angulée**

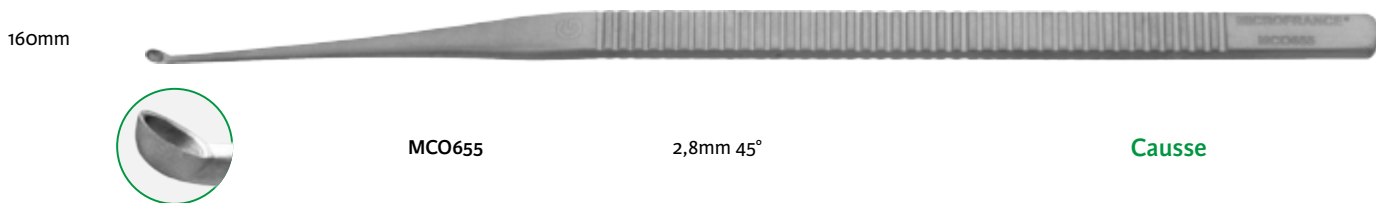

**Straight curette double-ended**

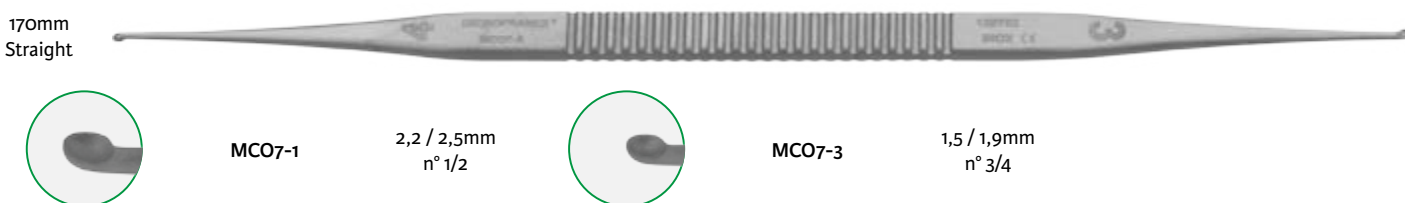

**Angled curette double ended**

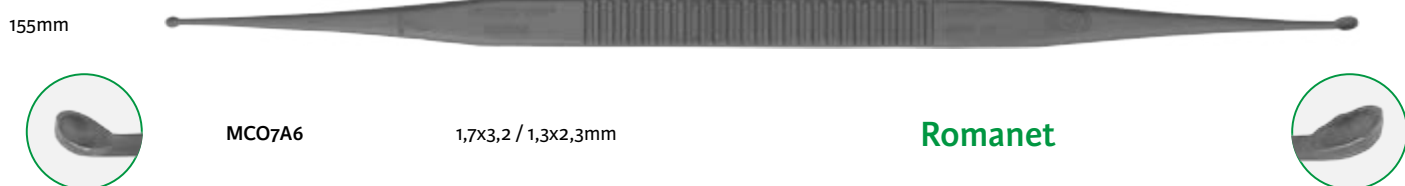
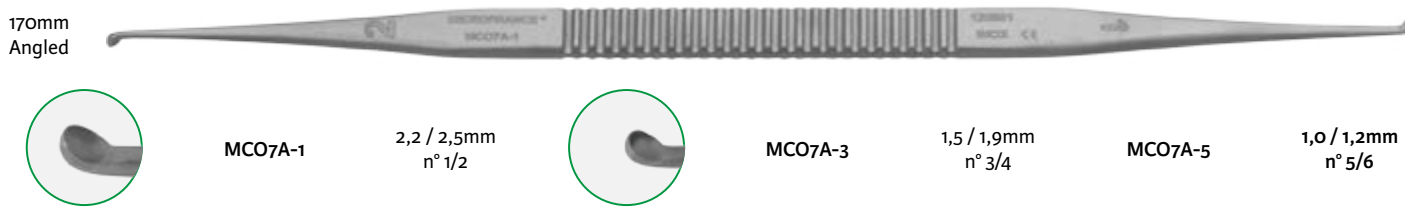

**Straight pick**

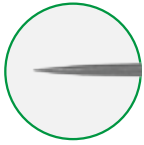

165mm

MCO31

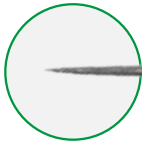

165mm

**Marquet**

MCO901  
angled shaft

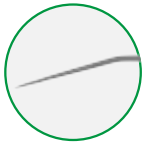

165mm

**Charachon**

MCO800  
bent shaft

**Curved pick**

165mm

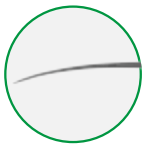

MCO32  
Medium curvature



MCO221  
Large curvature



MCO221A  
Short curvature

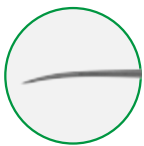

160mm

**Causse**

MCO657  
Medium curvature

**Curved pick, blunt**

165mm



MCO801  
Ø 0,8mm



**Causse**  
MCO666

**Tenotome probe**

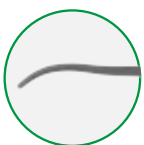

165mm

MCO802  
curved, blunt



Micro hook, tip straight shaft

165mm



45°

MCO6A  
0,7mm

**Charachon**  
MCO806  
2,0mm

**Legent**  
MCO807  
1,0mm

90°

MCO205  
0,3mm - right

MCO6B  
0,7mm

MCO806A  
2,0mm

MCO806B  
4,0mm

MCO950  
0,8mm  
**Marquet**

MCO654-1  
1,2mm - right  
**Causse**









MCO654-2  
1,2mm - left  
**Causse**

MCO841  
**Causse**

Micro hook, tip angled shaft

165mm



				Posterior	Anterior	Right	Left
<b>Marquet</b>		90° 0,2mm	MCO916	MCO915			
<b>Charachon</b>		90° 0,2mm	MCO832A	MCO832B	MCO832C	MCO832D	
		90° 0,3mm	MCO205A	MCO205B	MCO205C	MCO205D	
<b>Causse</b>		0,2mm	MCO663-2	MCO663-1			
<b>Causse</b>		0,4mm	MCO662-2	MCO662-1			
<b>Causse</b>		90° 0,4mm		MCO664			
<b>Causse</b>		90° 0,7mm		MCO665			
<b>Marquet</b>		45° 0,9mm			MCO920		

Micro hook, tip bent shaft

165mm



**Poncet**



90°  
0,5mm

MCO226A  
Posterior

MCO226  
Anterior

MCO226B  
Right

MCO226C  
Left

**Micro hook, spoon handle**

**Portmann**

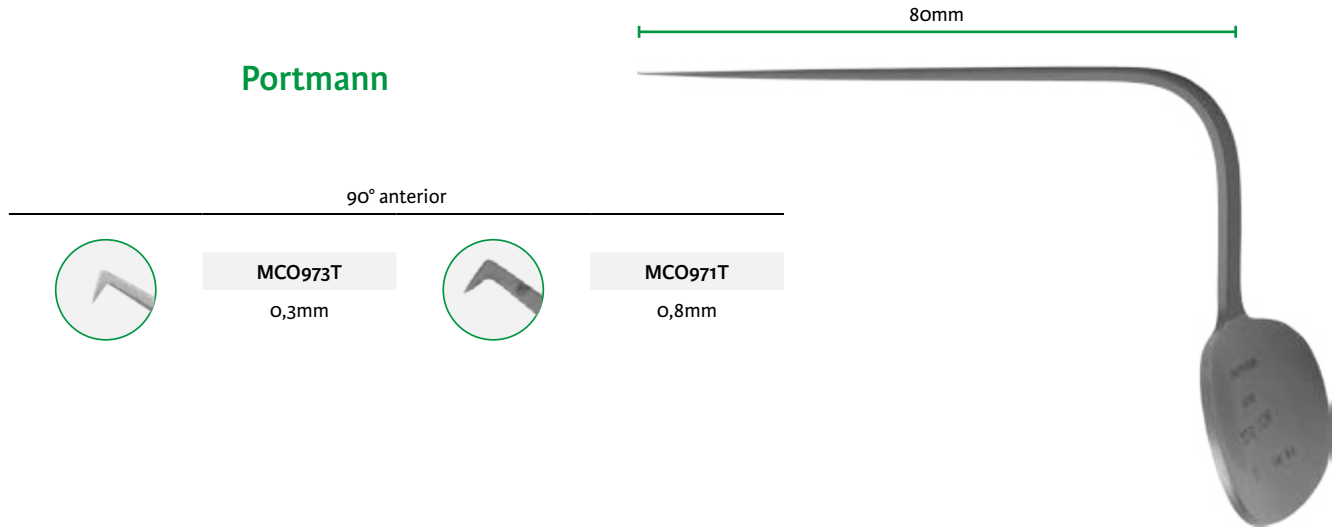

**Micro raspatory**

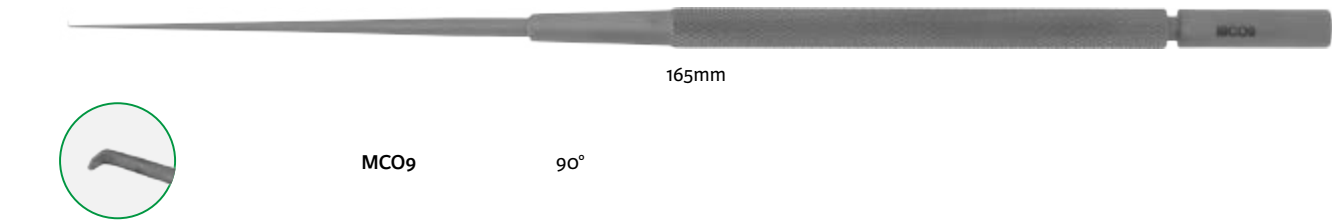

**Micro hook - Micro raspatory**

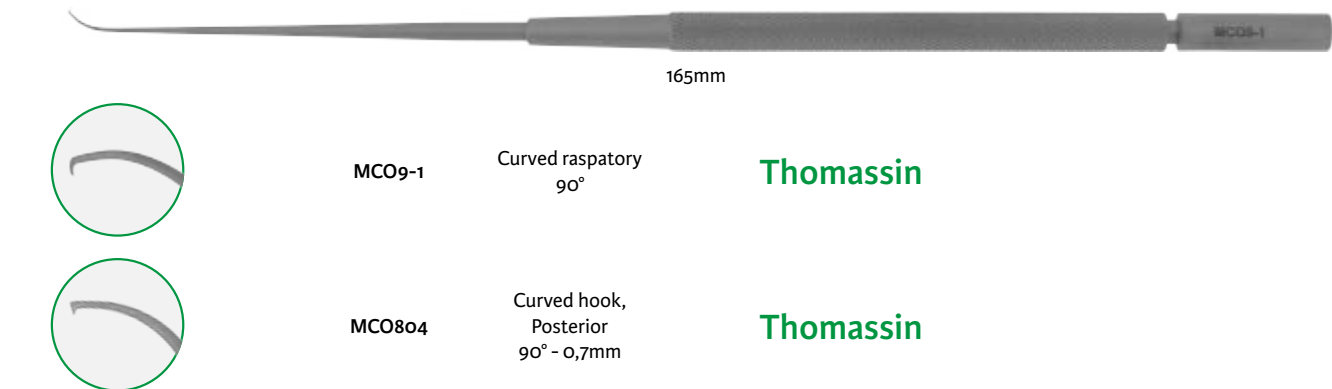

**Includostapedial joint knife**

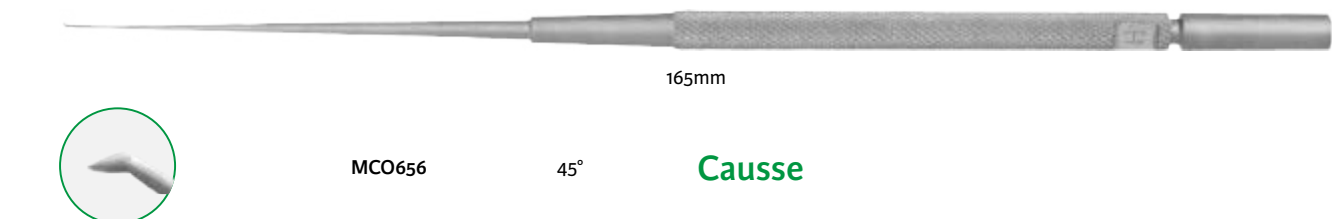

Curved monopolar elevator



MCO8BM

**Bordure**

140mm

Curved monopolar pick blunt



MCO989

**Legent**

180mm

Monopolar cables - 4,5 m



**CP391E**  
Erbe Storz Wolf



**CP391M**  
Aesculap Berchtold Martin  
Erbe T Serie Lamidey



**CP391V**  
Bowa Emc Lamidey Valleylab

Scale 1/4

Bipolar forceps

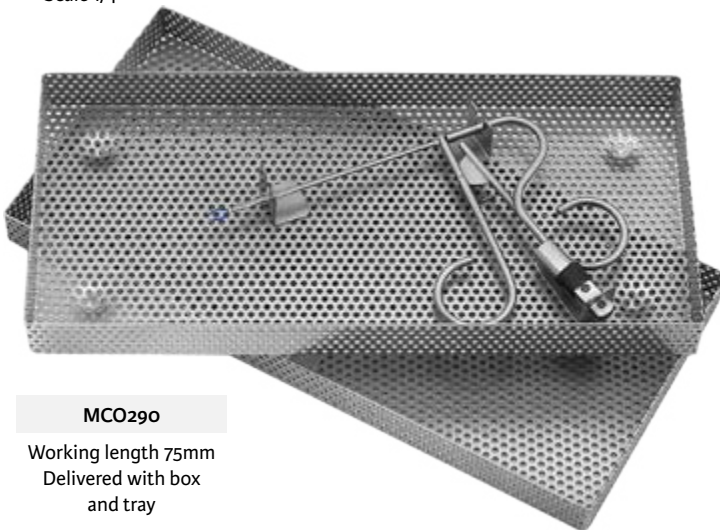

**MCO290**

Working length 75mm  
Delivered with box  
and tray

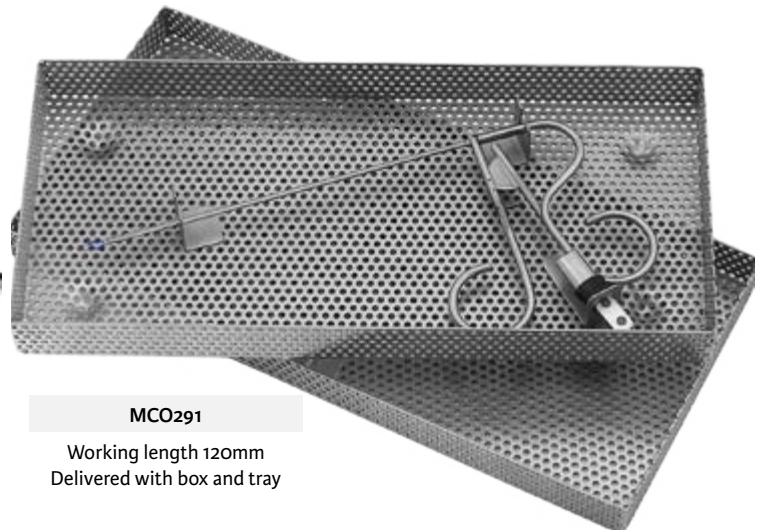

**MCO291**

Working length 120mm  
Delivered with box and tray

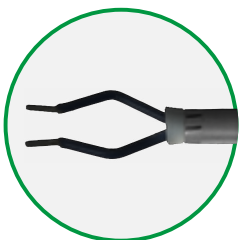

Bipolar cables - 4,5 m



**CP393-2**  
Bowa Emc Lamidey Valleylab



**CP393-3**  
Erbe Storz Wolf



**CP393-4**  
Aesculap Berchtold Martin

Micro measuring rod, angled shaft

165mm

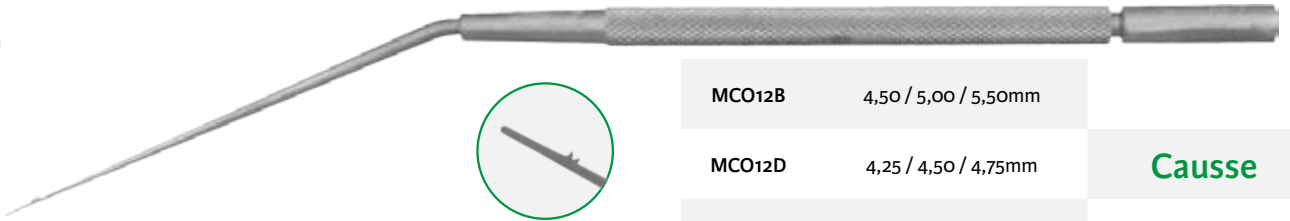

MCO12B 4,50 / 5,00 / 5,50mm

MCO12D 4,25 / 4,50 / 4,75mm

Cause

MCO12H 3,50 / 4,00 / 4,50mm

Vincent

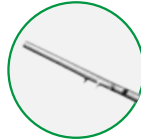

MCO12E 5,00 / 6,00 / 7,00 / 8,00mm

Vincent

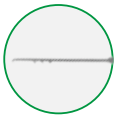

malleable

livré avec protection

MCO12R malleable shaft 3,00 / 4,00 / 5,00mm

Robier

165mm

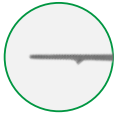

MCO830 straight shaft 3,50 / 4,00 / 4,50mm

Charachon

165mm

Ossiculoplasty sizer

MCOR45  
165mm



MCOR20	MCOR25	MCOR30	MCOR35	MCOR40	MCOR45	MCOR50
2,0mm	2,5mm	3,0mm	3,5mm	4,0mm	4,5mm	5,0mm
MCOR55	MCOR60	MCOR65	MCOR70	MCOR75	MCOR80	
5,5mm	6,0mm	6,5mm	7,0mm	7,5mm	8,0mm	

Columella distance measuring rod forceps

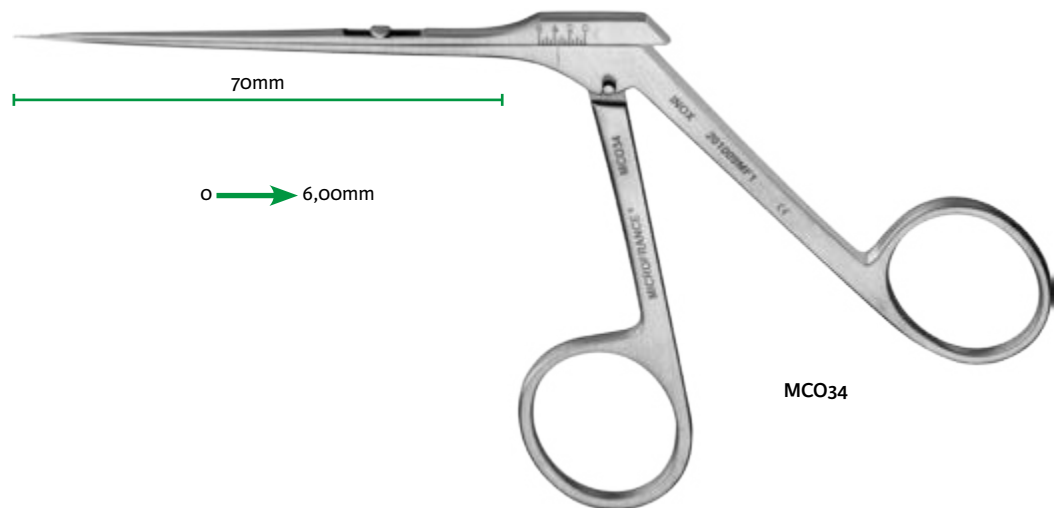

70mm

6,00mm

MCO34

Ossiculoplasty sizer

165mm



MCO844

1 → 10,0mm

Sauvage

Wire guide

165mm



MCO997

Legent

Ossicle holding clamp

120mm



3721060

Derlacki

Punch for silastic

Punch for silastic



MCO571  
Ø 2,5 - 0,8mm  
for silastic 1128305

Vincent

Fascia press

Sheehy

200mm

3724061

23x31mm

Scale 1/2



Scale 1/2

MCO819



Scale 1/2

MCO820

Martin

Cartilage cutting block

Teixido



MCO255

Cutting 0,3mm

Martin



MCO250

Cutting 0 to 1,5mm



Replacement blade

MCO255

Pack 10

**Hand drill pick**

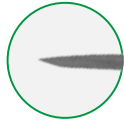

MCO218-4	0,4mm		165mm
MCO218-6	0,6mm	pick	
MCO218-8	0,8mm		

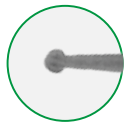

MCO29-1	0,6mm		125mm
MCO29	0,8mm	burr	

**Piston trimming gauge**



MCO213-4	∅ 0,4 / 0,6mm
	Length
	3,0 → 6,0mm

**Preparation glass plate**

**Cause**

**House**

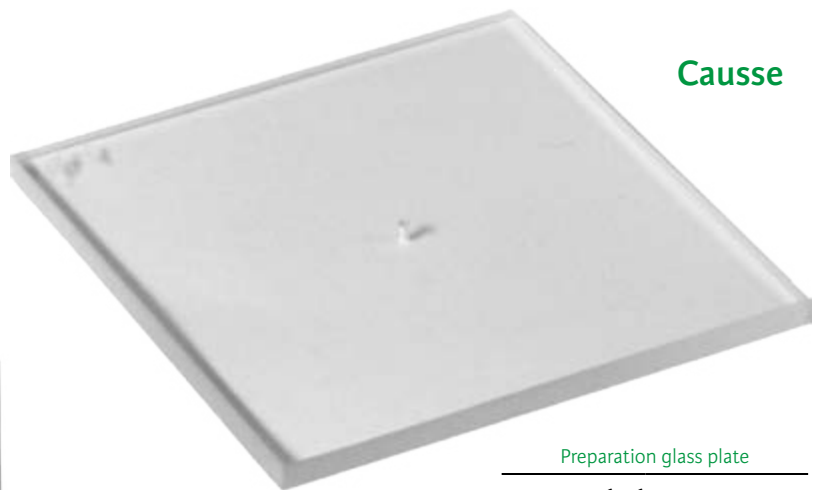

Teflon cutting block

<b>3724064</b>
73x38x9mm

Preparation glass plate

65x65x4mm	
with hole	
MCO660-10	Hole 1,0mm
MCO660-12	Hole 1,2mm
MCO660-8	Hole 0,8mm
without hole	
MCO660-2	65x65x2mm

Otoplasty

Stenstrom



Otoabrader rasp  
160mm  
2,0x8,0mm

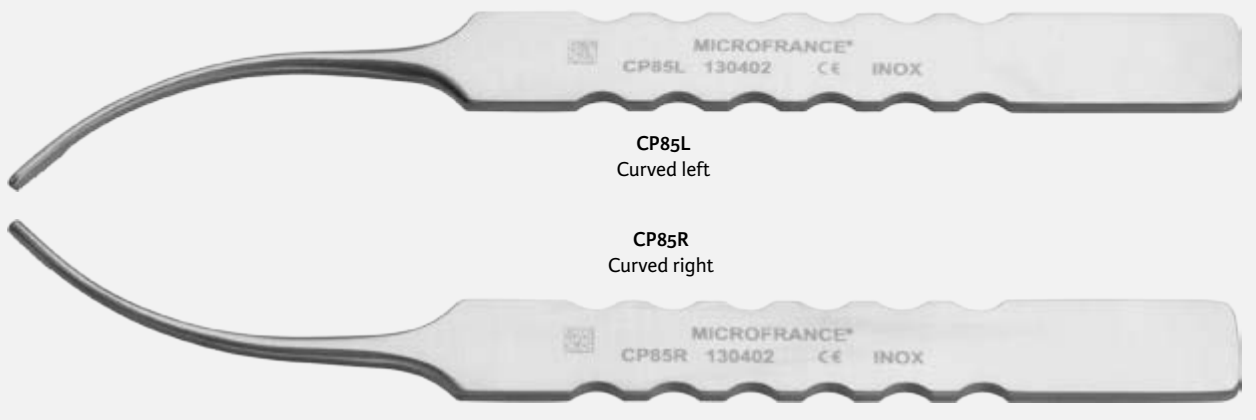

Stenstrom

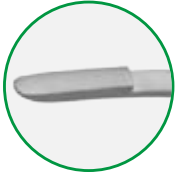

Elevator  
160mm  
2,0x8,0mm

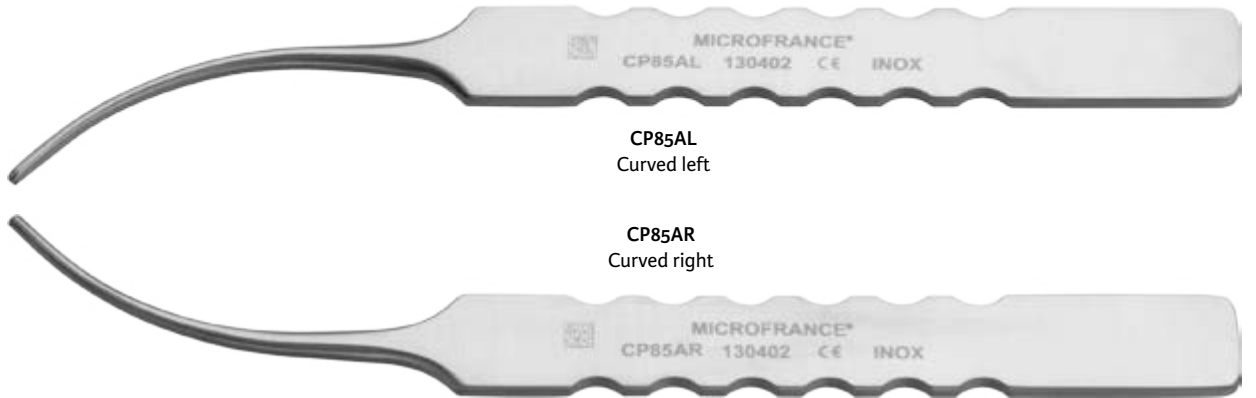

Temporal bone specimen holder



Ø 160mm

MCO823



Suction foot switch



Darrouzet

Scale 1/3

MCO551

Replacement accessories for suction foot switch



Security valve device

MCO551B

Pack 6































Trumpet valve device

MCO551A

## Composition of the Causse set

Reference	Description
7874MF-34	Stainless steel sterilization case 380x205x85mm 340x200x80mm
MCO12D	Causse measuring rod 4.25/4.5/4.75mm measurements angled shaft 165mm length
MCO12E	Vincent measuring rod 5/6/7/8mm measurements angled shaft 165mm length
MCO12H	Vincent measuring rod 3.5/4/4.5mm measurements angled shaft 165mm length
MCO13C	Hartmann forceps 3x0.6mm serrated jaws WL 65mm
MCO213-4	Piston trimming gauge with 0.4/0.6mm holes from 3 to 6mm 120mm length
MCO27	Dieter malleus nipper forceps 2.3mm jaws WL 65mm
MCO4A	Straight micro scissors blades 3mm tips WL 65mm
MCO571	Vincent punch 2.5x0.8mm diam. for Silastic 1128305
MCO649SC	Causse sterilization tray 520x250x100mm
MCO650	Causse knife 90° 3mm diam. tip bent shaft (A) 165mm length
MCO651	Causse lancet knife 45° bent shaft (B) 165mm length
MCO652	Causse knife 45° 3mm diam. tip (C) 165mm length
MCO653	Causse lancet knife 1.5x2mm 45° (D) 165mm length
MCO654-1	Causse tendon hook cutting right 90° 1.2mm (E1) 165mm length
MCO654-2	Causse tendon hook left 90° 1.2mm (E2) 165mm length
MCO655	Causse angled curette 2.8mm diam. tip (G) 160mm length
MCO656	Causse incudostapedial joint knife 45° (H) 165mm length
MCO657	Causse curved pick (I) 160mm length
MCO658	Causse piston crimping forceps WL 65mm
MCO660-10	Causse preparation glass plate 65x65x4mm with hole 1mm diam.
MCO660-12	Causse preparation glass plate 65x65x4mm with hole 1.2mm diam.
MCO660-2	Causse preparation glass plate 65x65x2mm
MCO660-8	Causse preparation glass plate 65x65x4mm with hole 0.8mm diam.
MCO661-10	Causse malleable suction tube with luer-lock connection 1mm diam. WL 90mm
MCO661-7	Causse malleable suction tube with luer-lock connection 0.7mm diam. WL 90mm
MCO662-1	Causse anterior curved hook 0.4mm tip angled shaft (O1) 165mm length
MCO662-2	Causse posterior curved hook 0.4mm tip angled shaft (O2) 165mm length
MCO663-1	Causse anterior curved hook 0.2mm tip angled shaft (P1) 165mm length
MCO663-2	Causse posterior curved hook 0.2mm tip angled shaft (P2) 165mm length
MCO664	Causse anterior hook 90° 0.4mm tip angled shaft (Q) 165mm length
MCO665	Causse anterior hook 90° 0.7mm tip angled shaft (R) 165mm length
MCO666	Causse curved pick dull (S) 165mm length
MCO667	Causse flap elevator 45° 165mm length
MCO820	Martin fascia press
MCO841	Causse hook 90° (F) 165mm length

		
MCO13C	MCO213-4	MCO27
		
MCO4A	MCO571	MCO820
		
MCO670-1	7874MF-34	MCO649SC
		
MCO650	MCO651	MCO652
		
MCO653	MCO654-1	MCO654-2
		
MCO655	MCO656	MCO657
		
MCO662-1	MCO663-1	MCO665
		
MCO657	MCO658	MCO841
		
MCO12H	MCO12E	MCO661-10
		
MCO660-12	MCO660-2	

Photos for illustration purposes, unscaled

**Lancet knife**

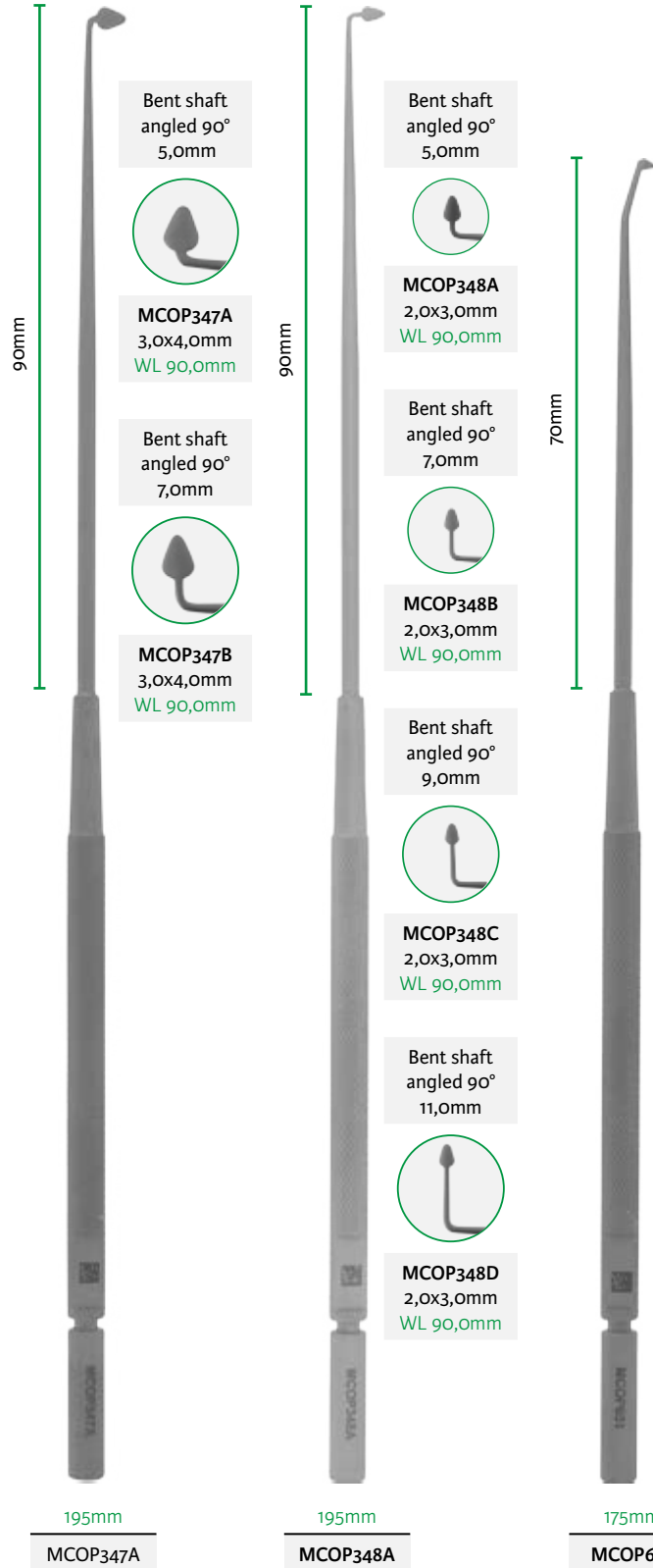

**Curette**



**Suction tube elevator**

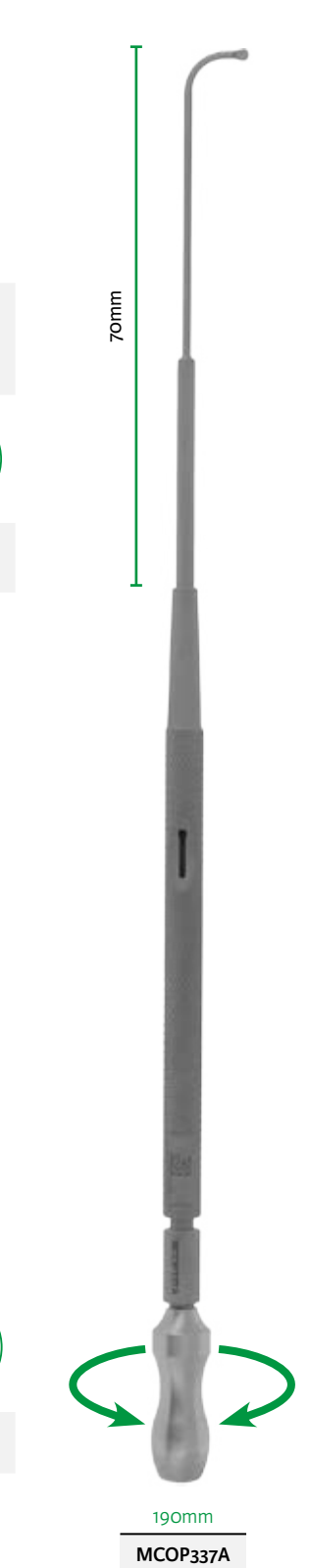

WL Working Length

**Suction tube with finger control**

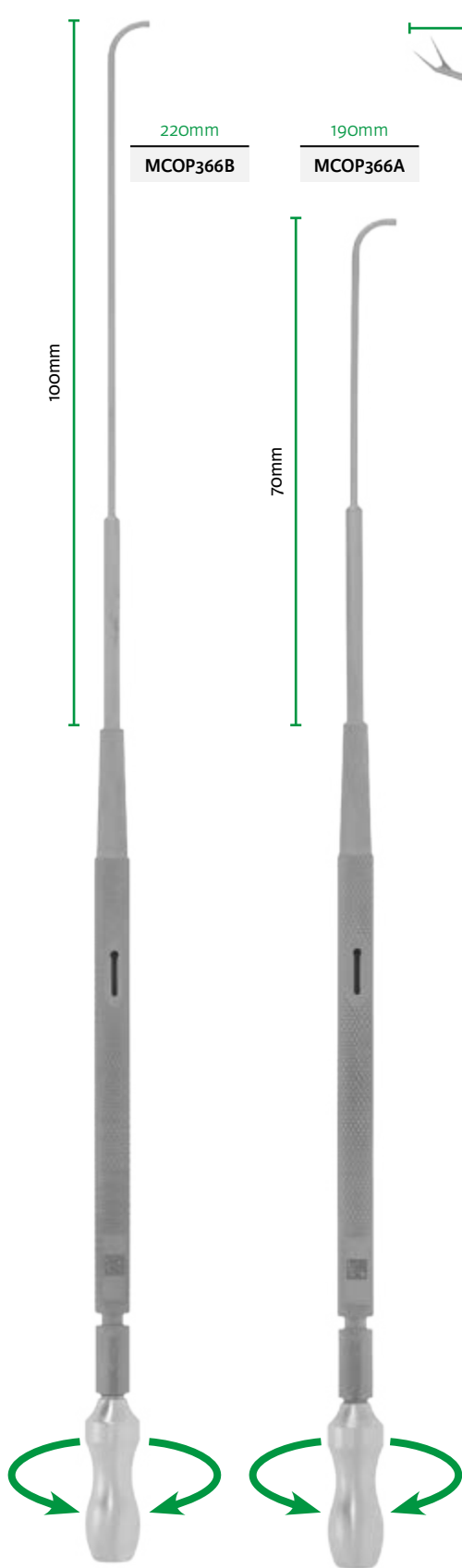

**Alligator forceps**

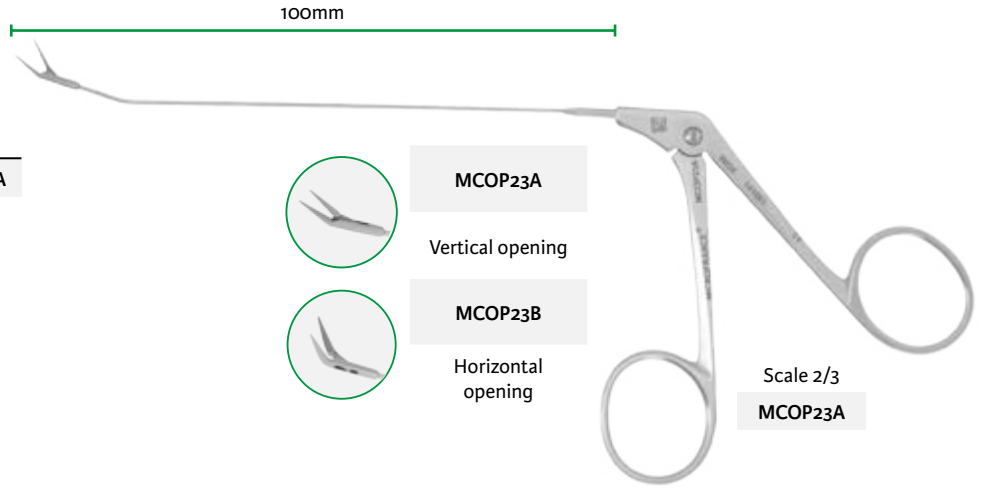

**Wire crimper forceps**

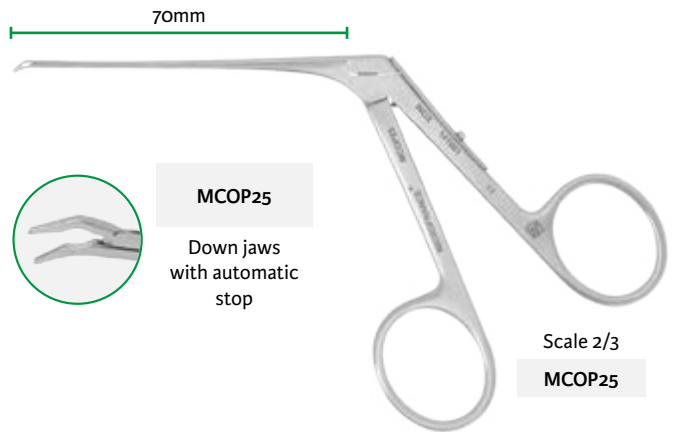

**Fascia press**

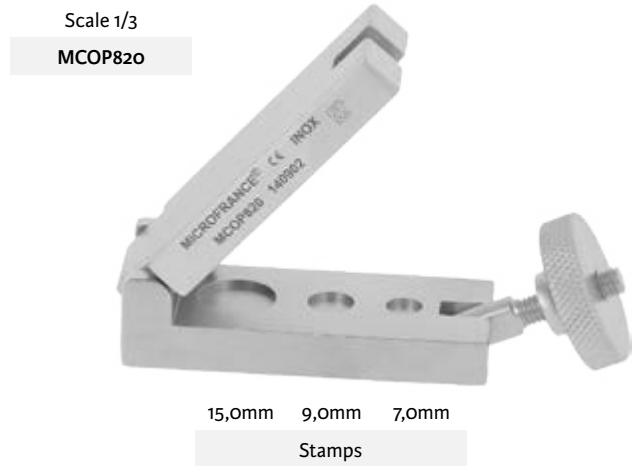

### Raspatory - Hook

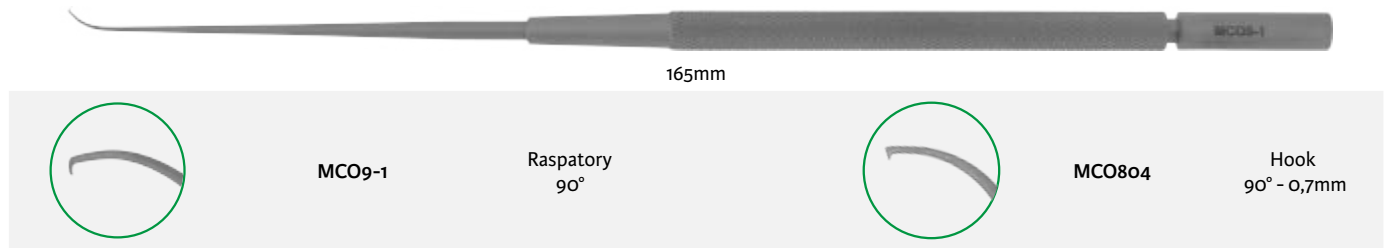

### Double elevator

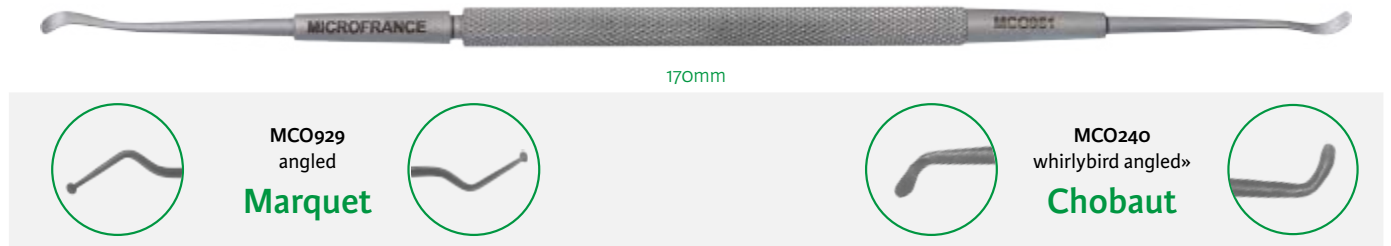

### Suction tube adapter - Angled suction tube with luer-lock connection

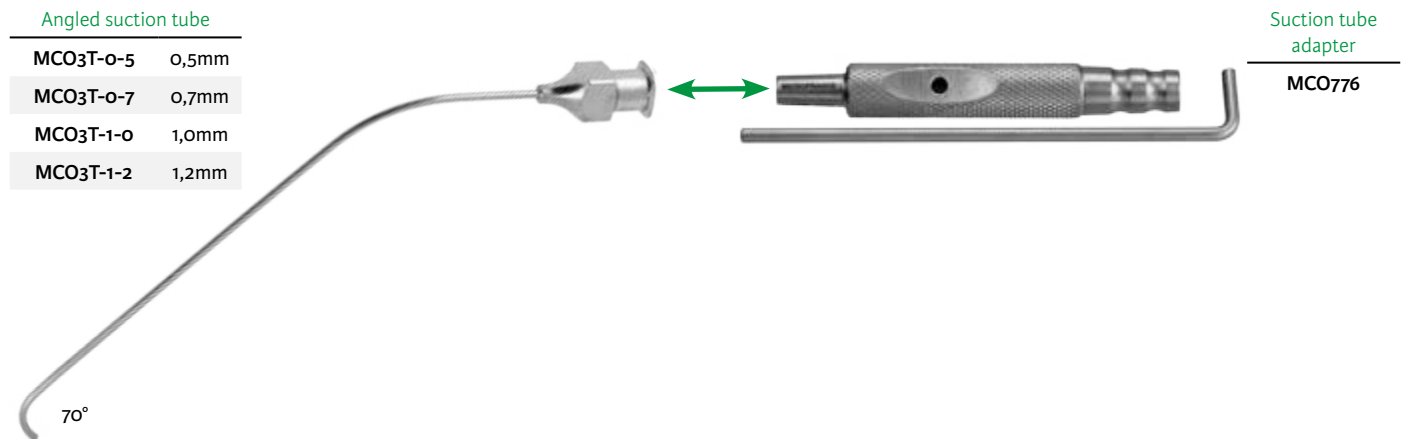

**Forceps**

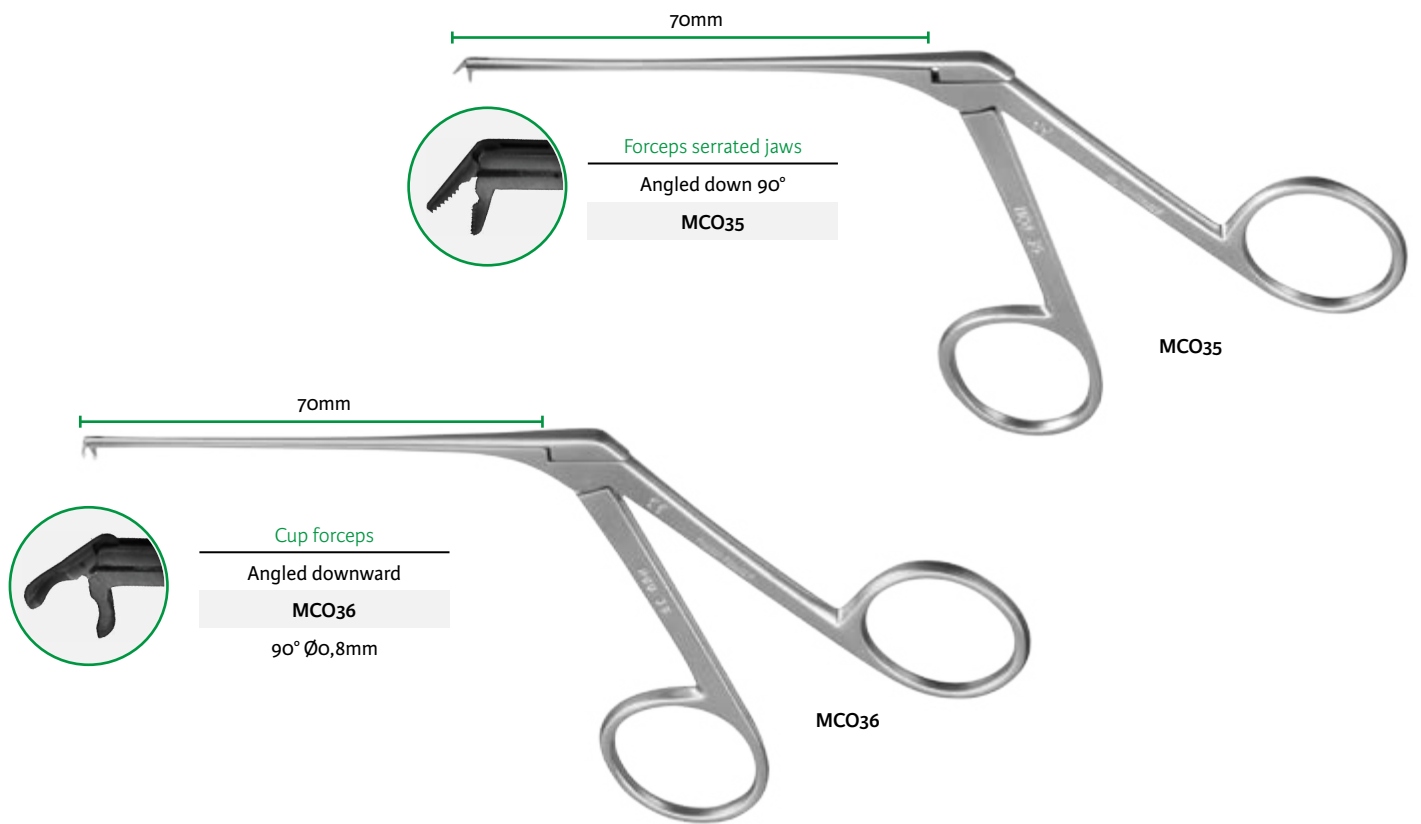

**Sterilization case - Sterilization tray**

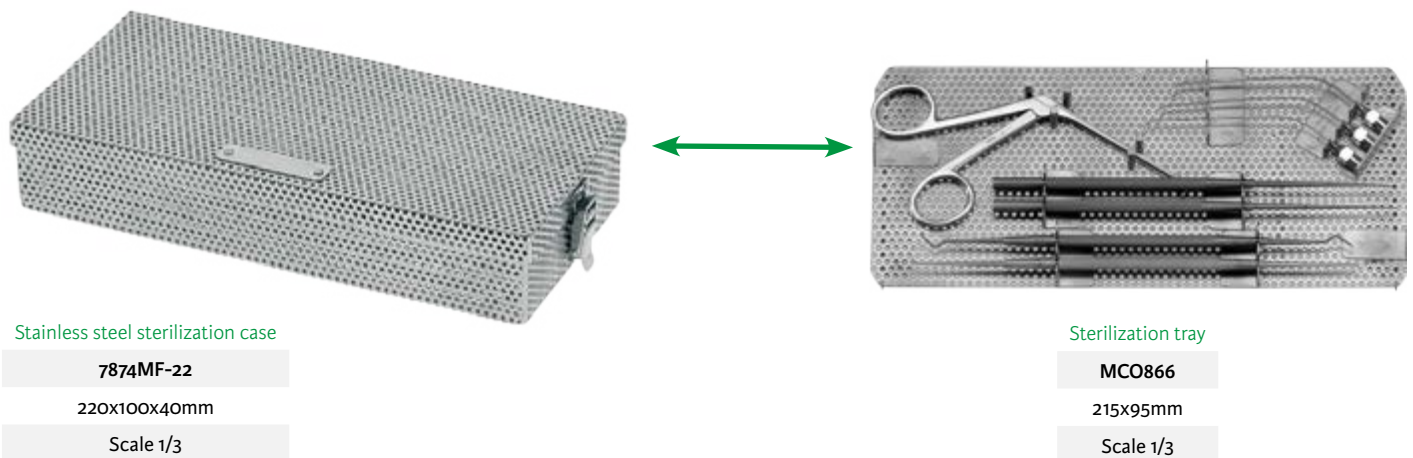

Stainless steel sterilization case

**7874MF-22**

220x100x40mm

Scale 1/3

Sterilization tray

**MCO866**

215x95mm

Scale 1/3

Blunt eyes suction tube with luer-lock connection

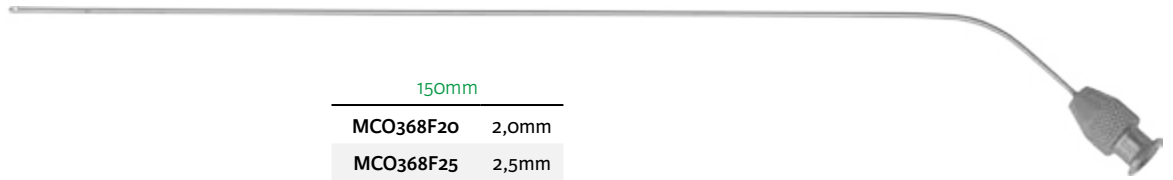

**Fraysse**



**Dubreuil**

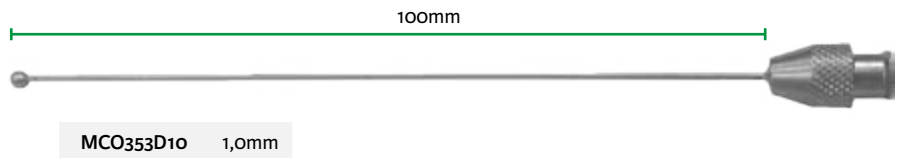

**Zimmermann**

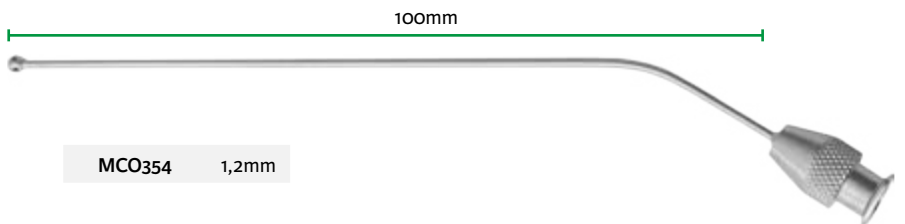



**Blunt eyes suction tube with finger control**

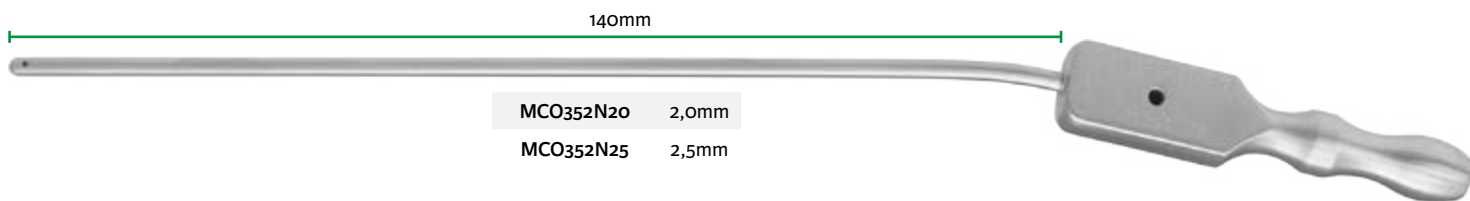

**Charachon**

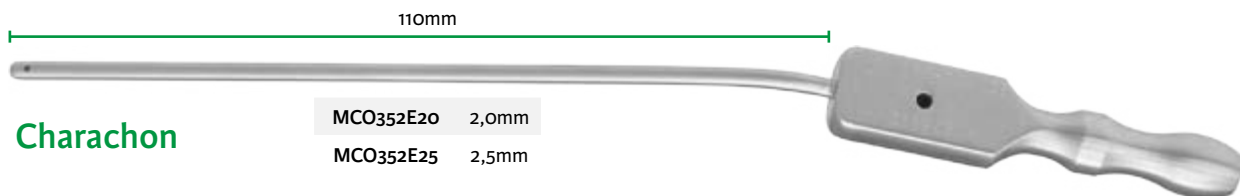

**House**

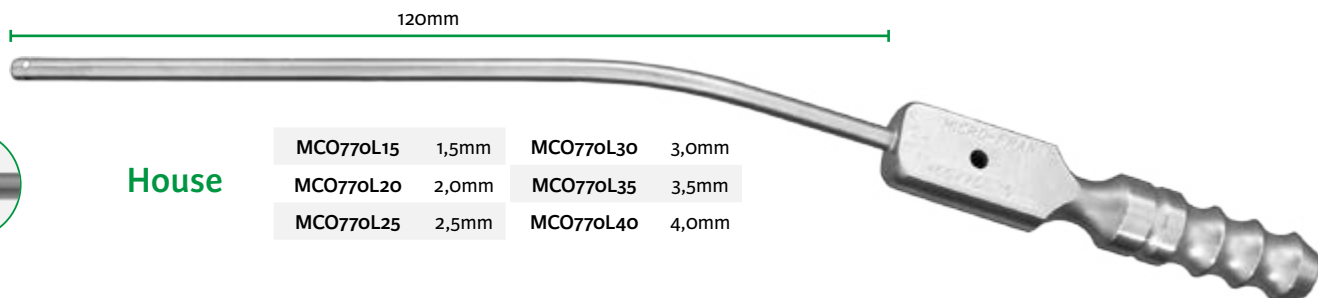

**Blunt eyes suction irrigation tube with finger control**

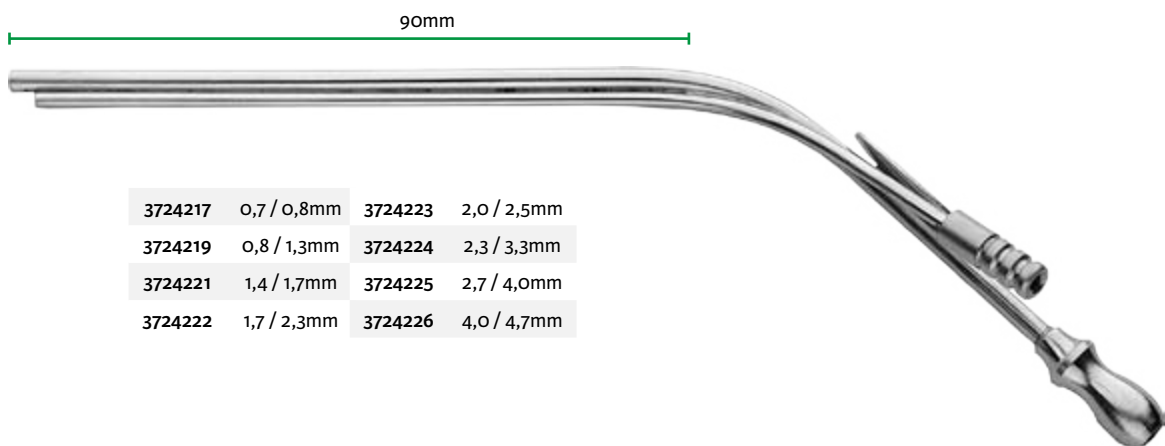

**Brackman**



Forceps - Scissors

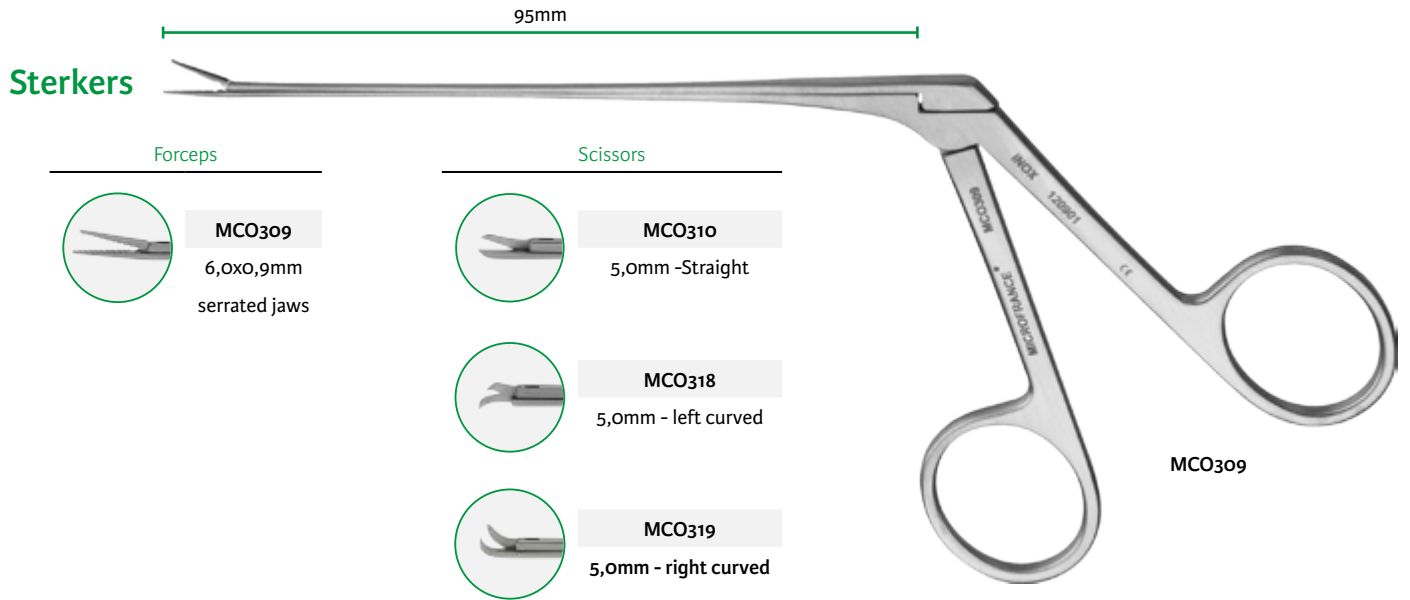

Articulated self-retaining retractor

Robier

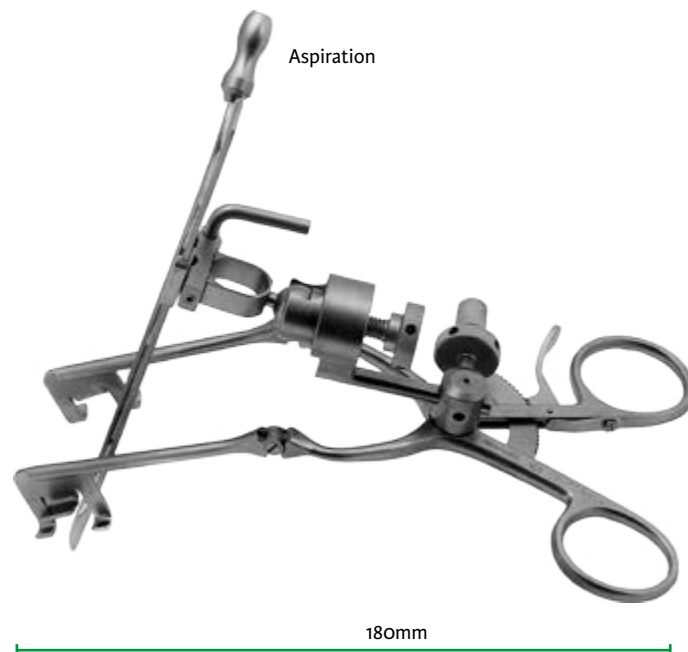

Articulated self-retaining retractor

- MCO357A**
- with suction tube blade
- Scale 1/2

Curved self-retaining retractor

Angot-Vaneecloo

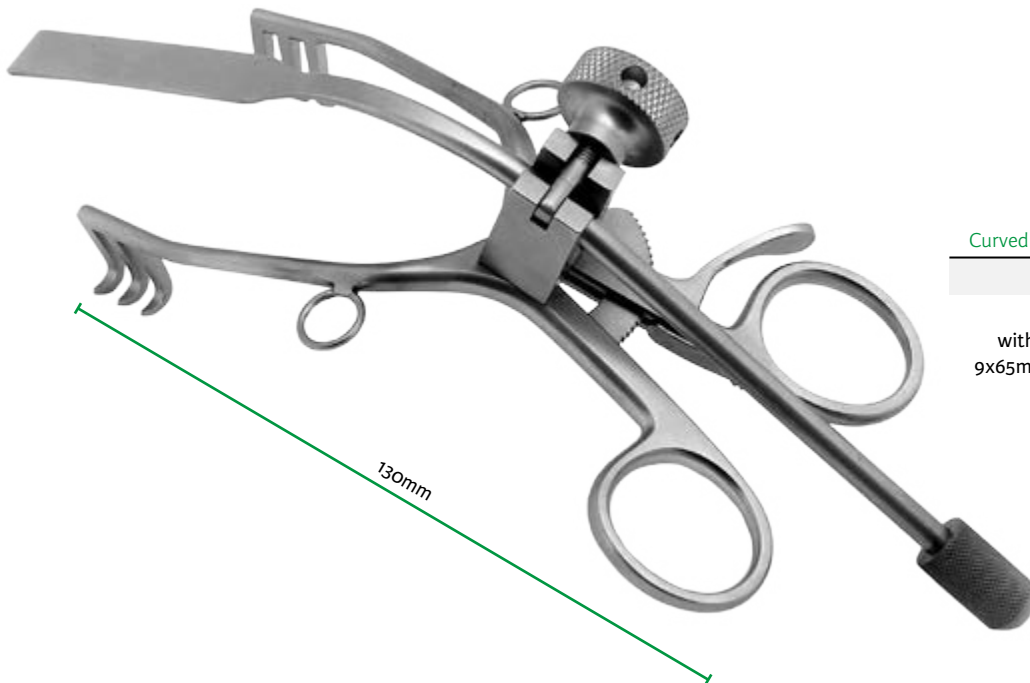

Curved self-retaining retractor

MCO351

3x3 prongs  
with 3 malleable blades  
9x65mm 9x75mm 12x55mm

**Sterkers Instruments**



180mm



**MCO301**  
Sickle knife



**MCO302**  
Hook  
90° 2,0mm



**MCO303**  
Hook  
90° 1,2mm



**MCO304**  
Hook  
90° 0,8mm



**MCO320**  
Fenestrated curette  
3,0mm

**Sterkers**

**Décolleurs**



195mm



**MCO333**

Curved elevator

**Klap**



180mm



**MCO337DL**

Whirlybird elevator left



**MCO337DR**

Whirlybird elevator right

**Dubreuil**

**Hook - Pick**



190mm



**Magnan**

**Bruzzo**

**MCO341**  
90° 2,0mm  
Left hook  
Bayonet shaft

**MCO340**  
90° 2,0mm  
Right hook  
Bayonet shaft

**MCO342**  
Blunt straight pick  
Bayonet shaft

**MCO343**  
Curved pick  
Bayonet shaft

**Mom instruments**



**Mom**

**MCO7AMO**

Angled curette double-ended

2,2 / 2,5mm

n° 1/2

190mm



Irrigation

190mm

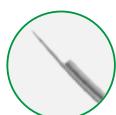
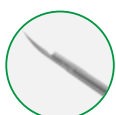

**MCO6M**  
Oval knife  
2,0x2,5mm

**MCO10MO**  
Sickle knife

**MCO221MO**  
Curved pick







**MCO330MO**  
Ball seeker  
2,0mm 90°

**Mom**

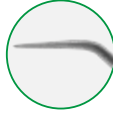
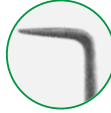



Micro instruments

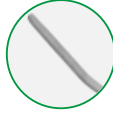

190mm

Hook			Knife			Curette	
							
<b>MCOS14</b> 45° 3,0mm	<b>MCOS15</b> 90° 2,0mm	<b>MCOS16</b> 90° 2,8mm	<b>MCOS17</b> <b>MCOS18</b> <b>MCOS19</b> 45° 1,0mm 2,0mm 3,0mm			<b>MCOS25</b> Ø 1,0mm Straight	<b>MCOS26</b> Ø 1,0mm Angled

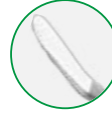

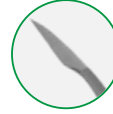

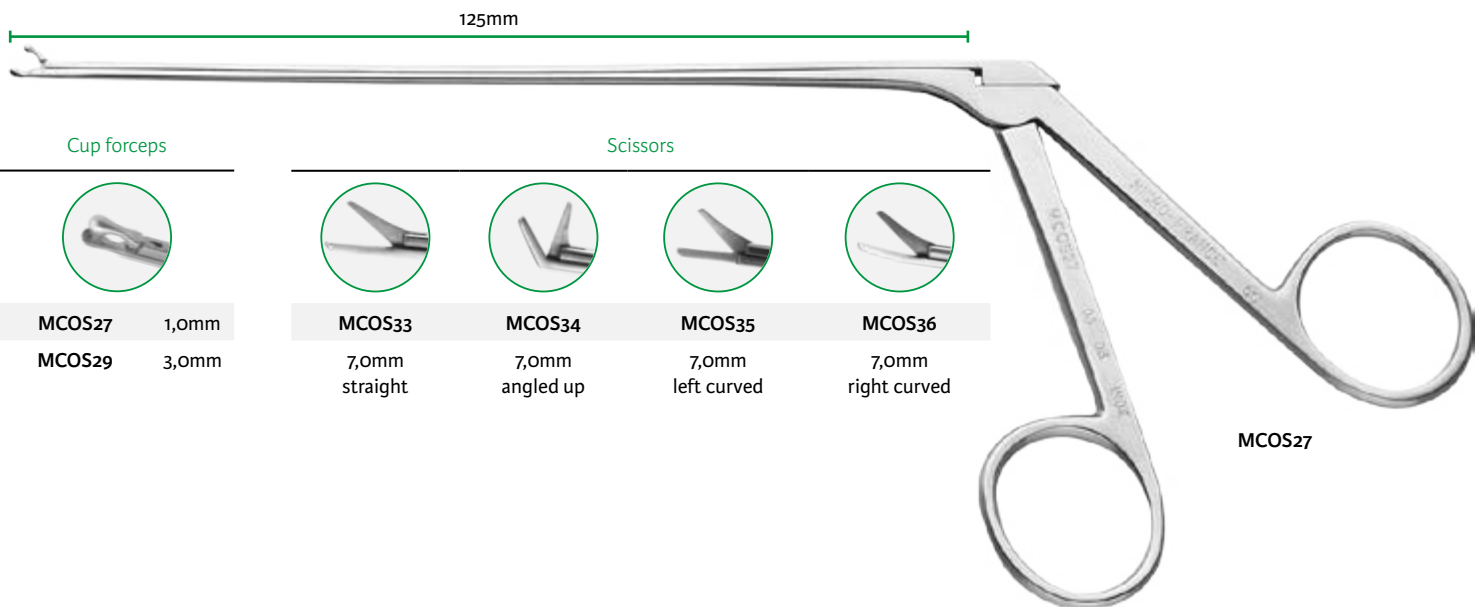

Selesnick

Elevator						Sickle knife
						
<b>MCOS20</b> angled 14,0 x 1,5mm	<b>MCOS21</b> curved 3,0mm	<b>MCOS22</b> spatula dissector 5,0 x 1,0mm	<b>MCOS23</b> spatula dissector 7,0 x 2,0mm	<b>MCOS30</b> left whirlybird	<b>MCOS31</b> right whirlybird	<b>MCOS32</b> 5,0mm sharp tip

Cup forceps - Scissors



125mm

Cup forceps		Scissors				
						
<b>MCOS27</b> 1,0mm	<b>MCOS29</b> 3,0mm	<b>MCOS33</b> 7,0mm straight	<b>MCOS34</b> 7,0mm angled up	<b>MCOS35</b> 7,0mm left curved	<b>MCOS36</b> 7,0mm right curved	<b>MCOS27</b>

### Curved self-retaining retractor, Stabilizing device

#### Angot-Vaneecloo

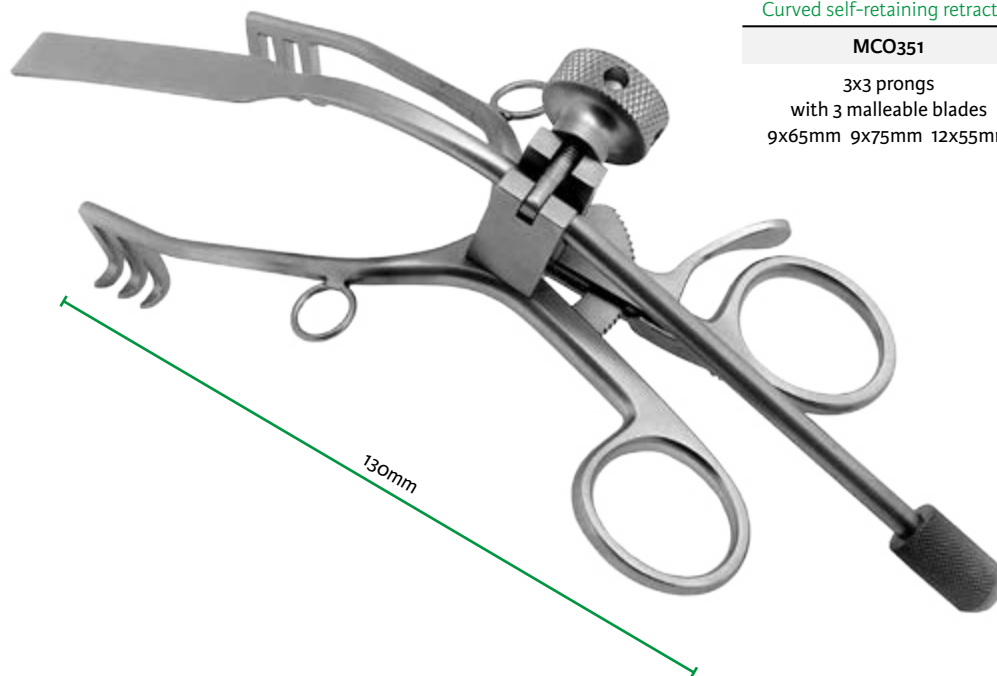

Curved self-retaining retractor

**MCO351**

3x3 prongs  
with 3 malleable blades  
9x65mm 9x75mm 12x55mm

#### Bipolar forceps

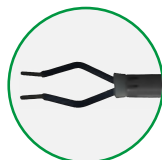
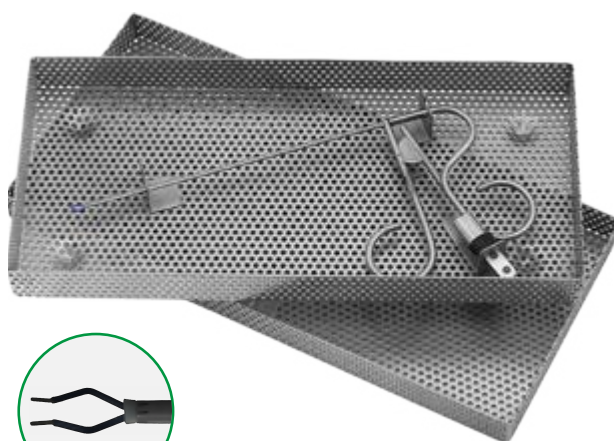

Page 55

Bipolar forceps

**MCO291**

Working length 120mm  
delivered with box and tray  
Scale 1/3









#### Sterilization case



Plastic Sterilization case

**3717022**

210x123x36mm  
for 16 picks  
Scale 1/5

Knife	Burrs				Tungsten helicoidal	Drill burr	Drill burr	
	Diamond	Tungsten round	Diamond	Perforer 6 sided			Six sided	Lindemann
shaft 44mm	shaft 65mm	65mm	65mm	65mm	shaft 35mm	shaft 55mm	shaft 33mm	50mm
<b>MCO702-22<sup>(D)</sup></b>								
Pack 1								
Ø 22 mm								
								
Ø mm	Pack 1	Pack 1	Pack 6	Pack 1	Pack 1	Pack 4	Pack 1	Pack 1
0,6	236HM-0-6 <sup>(D)</sup>	242-0-6 <sup>(D)</sup>	-	-	-	-	-	-
0,7	-	242-0-7 <sup>(D)</sup>	-	-	-	-	-	-
0,8	236HM-0-8 <sup>(D)</sup>	242-0-8 <sup>(D)</sup>	-	-	-	-	-	-
1,0	236HM-1-0 <sup>(D)</sup>	242-1-0 <sup>(D)</sup>	-	-	-	-	-	-
1,2	-	-	-	-	-	2035512C4 <sup>(D)</sup>	-	-
1,4	236HM-1-4 <sup>(D)</sup>	242-1-4 <sup>(D)</sup>	-	-	-	-	-	-
1,5	-	-	-	-	-	2035515C4 <sup>(D)</sup>	-	-
1,8	236HM-1-8 <sup>(D)</sup>	242-1-8 <sup>(D)</sup>	-	-	-	-	164RS-1-8 <sup>(D)</sup>	-
2,1	-	-	-	-	-	-	-	-
2,3	236HM-2-3 <sup>(D)</sup>	242-2-3 <sup>(D)</sup>	141P23 <sup>(D)</sup>	-	-	-	-	168RS <sup>(D)</sup>
2,7	236HM-2-7 <sup>(D)</sup>	242-2-7 <sup>(D)</sup>	141P27 <sup>(D)</sup>	-	-	-	-	-
3,0	236HM30 <sup>(D)</sup>	-	-	-	-	-	-	-
3,1	-	242-3-1 <sup>(D)</sup>	141P31 <sup>(D)</sup>	141RS-3-1 <sup>(D)</sup>	-	-	-	-
3,5	236HM-3-5 <sup>(D)</sup>	242-3-5 <sup>(D)</sup>	-	-	-	-	-	-
4,0	236HM-4-0 <sup>(D)</sup>	242-4-0 <sup>(D)</sup>	-	141RS-4-0 <sup>(D)</sup>	-	-	-	-
4,5	236HM-4-5 <sup>(D)</sup>	242-4-5 <sup>(D)</sup>	-	-	-	-	-	-
5,0	236HM-5-0 <sup>(D)</sup>	242-5-0 <sup>(D)</sup>	-	141RS-5-0 <sup>(D)</sup>	-	-	-	-
6,0	-	242-6-0 <sup>(D)</sup>	-	-	HM75GL-6-0 <sup>(D)</sup>	-	-	-
7,0	236HM-7-0 <sup>(D)</sup>	242-7-0 <sup>(D)</sup>	-	-	-	-	-	-

Sterilization tray

Sterilization case

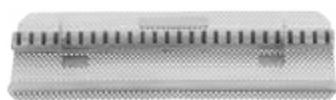

MCO865-1

for 26 burrs - Scale 1/5



7874MF-22

240x105x45mm 220x100x40mm - Scale 1/5

<sup>(D)</sup> Distributed by Integra MicroFrance SAS (France)



### Stainless steel cup



7876-60<sup>(D)</sup>

#### Cup

7876-60 <sup>(D)</sup>	60mm
7876-80 <sup>(D)</sup>	80mm
7876-100 <sup>(D)</sup>	100mm
7876-120 <sup>(D)</sup>	120mm
7876-160 <sup>(D)</sup>	160mm

### Stainless steel tray



7872-24<sup>(D)</sup>  
Scale 1/2

#### Stainless steel tray

7872-24 <sup>(D)</sup>	240x180mm
------------------------	-----------

### Surgical instrument oil



#### Surgical instrument oil

MCO731<sup>(D)</sup>

<sup>(D)</sup> Distributed by Integra MicroFrance SAS (France)

Scale 1/5

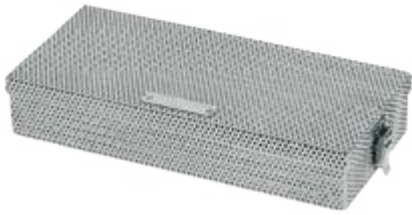

**7874MF-22**

240x105x45mm  
220x100x40mm

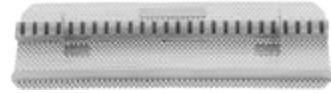

**MCO865-1**

for 26 burs

Scale 1/5

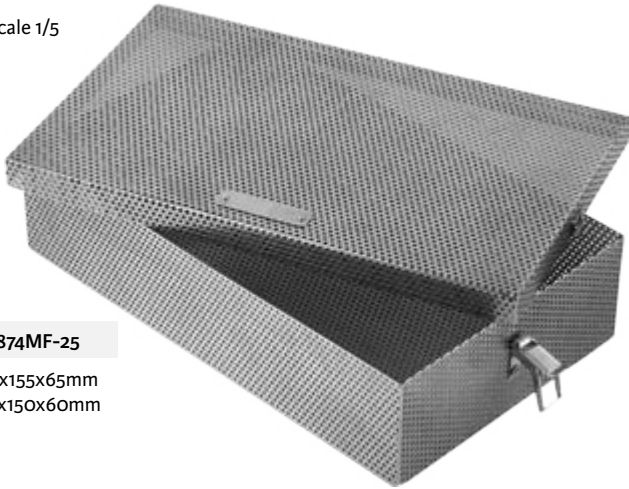

**7874MF-25**

270x155x65mm  
250x150x60mm

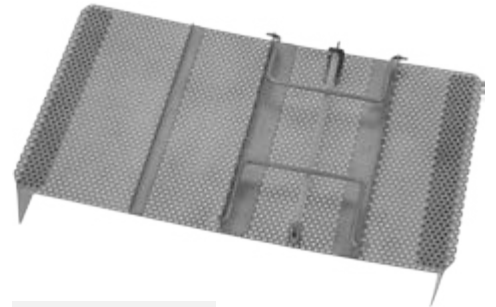

**MCO821-1**

12 instruments

Scale 1/5

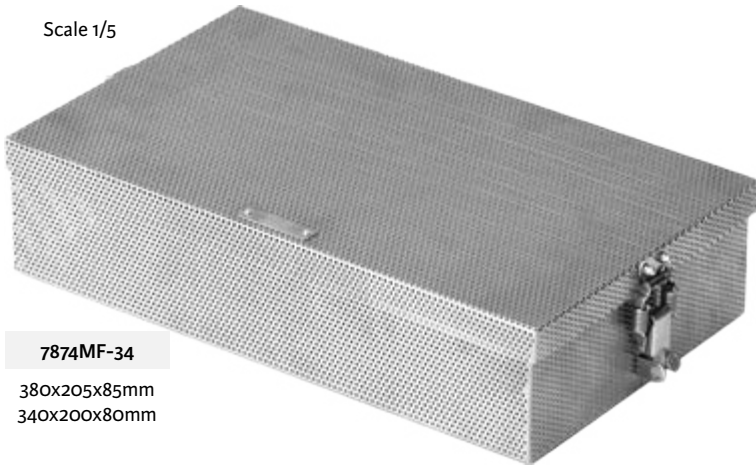

**7874MF-34**

380x205x85mm  
340x200x80mm

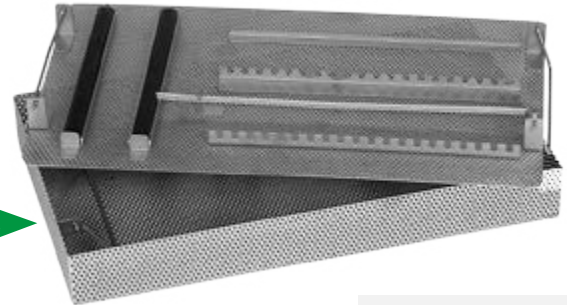

**MCO824-1**

Micro instruments set

Scale 1/5

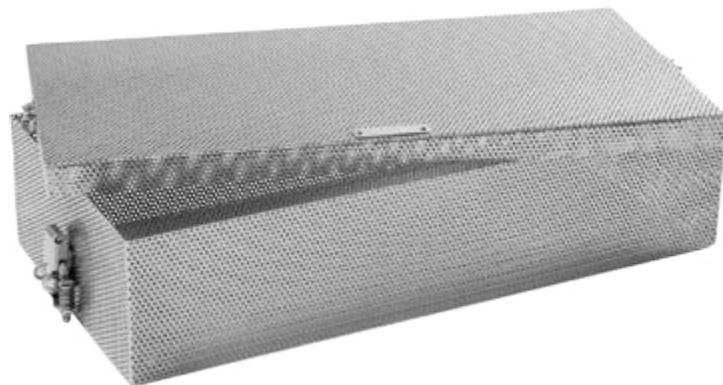

**7874MF-40**

440x205x95mm - 400x200x90mm

Scale 1/5

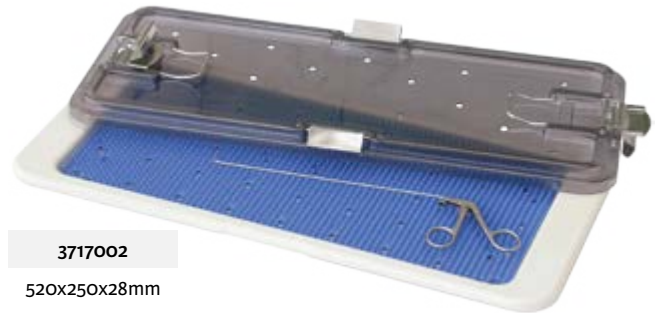

**O**

0208 ..... 7  
 0-28-1 .....19  
 0-28-2 .....19  
 0-28-3 .....20  
 0-28-4 .....20  
 0-28-7 .....22  
 0-28-8 .....19

**1**

1003IG<sup>(D)</sup> ..... 8  
 1003LI<sup>(D)</sup> ..... 8  
 1004IG<sup>(D)</sup> ..... 8  
 1005I<sup>(D)</sup> ..... 8  
 1352247 ..... 22  
 1352248 ..... 22  
 1352321 ..... 7  
 1358270 ..... 44  
 1359254 ..... 44  
 1359256 ..... 44  
 1359258 ..... 44  
 1359260 ..... 44  
 1359262 ..... 44  
 1359264 ..... 44  
 1411000 ..... 7  
 1411050 ..... 7  
 141P23<sup>(D)</sup> ..... 76  
 141P27<sup>(D)</sup> ..... 76  
 141P31<sup>(D)</sup> ..... 76  
 141RS-3-1<sup>(D)</sup> ..... 76  
 141RS-4-0<sup>(D)</sup> ..... 76  
 141RS-5-0<sup>(D)</sup> ..... 76  
 1458230 ..... 7  
 1458231 ..... 7  
 1458232 ..... 7  
 1458233 ..... 7  
 1458234 ..... 7  
 1458275 ..... 7  
 1458276 ..... 7  
 164RS-1-8<sup>(D)</sup> ..... 76  
 168RS<sup>(D)</sup> ..... 76

**2**

2035512C4<sup>(D)</sup> ..... 76  
 2035515C4<sup>(D)</sup> ..... 76  
 236HM-0-6<sup>(D)</sup> ..... 76  
 236HM-0-8<sup>(D)</sup> ..... 76  
 236HM-1-0<sup>(D)</sup> ..... 76  
 236HM-1-4<sup>(D)</sup> ..... 76  
 236HM-1-8<sup>(D)</sup> ..... 76  
 236HM-2-3<sup>(D)</sup> ..... 76  
 236HM-2-7<sup>(D)</sup> ..... 76  
 236HM-3-5<sup>(D)</sup> ..... 76

236HM-4-0<sup>(D)</sup> ..... 76  
 236HM-4-5<sup>(D)</sup> ..... 76  
 236HM-5-0<sup>(D)</sup> ..... 76  
 236HM-7-0<sup>(D)</sup> ..... 76  
 236HM30<sup>(D)</sup> ..... 76  
 242-0-6<sup>(D)</sup> ..... 76  
 242-0-7<sup>(D)</sup> ..... 76  
 242-0-8<sup>(D)</sup> ..... 76  
 242-1-0<sup>(D)</sup> ..... 76  
 242-1-4<sup>(D)</sup> ..... 76  
 242-1-8<sup>(D)</sup> ..... 76  
 242-2-3<sup>(D)</sup> ..... 76  
 242-2-7<sup>(D)</sup> ..... 76  
 242-3-1<sup>(D)</sup> ..... 76  
 242-3-5<sup>(D)</sup> ..... 76  
 242-4-0<sup>(D)</sup> ..... 76  
 242-4-5<sup>(D)</sup> ..... 76  
 242-5-0<sup>(D)</sup> ..... 76  
 242-6-0<sup>(D)</sup> ..... 76  
 242-7-0<sup>(D)</sup> ..... 76

**3**

3711002 ..... 13  
 3711004 ..... 13  
 3711007 ..... 13  
 3711102 ..... 13  
 3711103 ..... 13  
 3712002 ..... 26  
 3712003 ..... 26  
 3712200 ..... 26  
 3712201 ..... 26  
 3712211 ..... 27  
 3714018 ..... 17  
 3714027 ..... 18  
 3714028 ..... 18  
 3714032 ..... 18  
 3714044 ..... 18  
 3714053 ..... 25  
 3714105 ..... 24  
 3714115 ..... 15  
 3714116 ..... 15  
 3714184 ..... 18  
 3714247 ..... 14  
 3714249 ..... 14  
 3714350 ..... 24  
 3717002 ..... 79  
 3717011 ..... 79  
 3717012 ..... 79  
 3717022 ..... 75, 79  
 3721000 ..... 5  
 3721005 ..... 5  
 3721060 ..... 57  
 3722009 ..... 49  
 3722140 ..... 51

3724011 ..... 4  
 3724012 ..... 4  
 3724013 ..... 4  
 3724014 ..... 4  
 3724015 ..... 4  
 3724016 ..... 4  
 3724017 ..... 4  
 3724018 ..... 4  
 3724019 ..... 4  
 3724020 ..... 4  
 3724023 ..... 4  
 3724024 ..... 4  
 3724027 ..... 3  
 3724028 ..... 3  
 3724029 ..... 3  
 3724043 ..... 23  
 3724044 ..... 23  
 3724045 ..... 23  
 3724046 ..... 23  
 3724047 ..... 23  
 3724055 ..... 4  
 3724056 ..... 4  
 3724057 ..... 4  
 3724061 ..... 58  
 3724064 ..... 59  
 3724066 ..... 20  
 3724067 ..... 20  
 3724068 ..... 21  
 3724069 ..... 20  
 3724070 ..... 20  
 3724093 ..... 10  
 3724094 ..... 10  
 3724095 ..... 10  
 3724096 ..... 10  
 3724097 ..... 10  
 3724098 ..... 10  
 3724099 ..... 10  
 3724100 ..... 10  
 3724101 ..... 9  
 3724102 ..... 9  
 3724103 ..... 9  
 3724104 ..... 9  
 3724105 ..... 9  
 3724106 ..... 9  
 3724107 ..... 9  
 3724108 ..... 10  
 3724109 ..... 10  
 3724110 ..... 10  
 3724111 ..... 10  
 3724112 ..... 10  
 3724113 ..... 10  
 3724114 ..... 10  
 3724122 ..... 10  
 3724123 ..... 10

3724124 ..... 10  
 3724125 ..... 10  
 3724126 ..... 10  
 3724127 ..... 10  
 3724128 ..... 10  
 3724141 ..... 10  
 3724142 ..... 10  
 3724143 ..... 10  
 3724144 ..... 10  
 3724145 ..... 10  
 3724146 ..... 10  
 3724147 ..... 10  
 3724148 ..... 10  
 3724150 ..... 10  
 3724151 ..... 10  
 3724183 ..... 43  
 3724184 ..... 43  
 3724185 ..... 43  
 3724217 ..... 69  
 3724219 ..... 69  
 3724221 ..... 69  
 3724222 ..... 69  
 3724223 ..... 69  
 3724224 ..... 69  
 3724225 ..... 69  
 3724226 ..... 69  
 3724231 ..... 2  
 3724232 ..... 2  
 3724233 ..... 2  
 3724234 ..... 2  
 3724235 ..... 2  
 3724240 ..... 21  
 3724241 ..... 21  
 3724242 ..... 21  
 3724244 ..... 22  
 3724245 ..... 22  
 3724293 ..... 49  
 3724332 ..... 19  
 3724333 ..... 22  
 3724401 ..... 10  
 3724402 ..... 10  
 3724403 ..... 10  
 3724404 ..... 10  
 3724405 ..... 10  
 3724406 ..... 10  
 3724407 ..... 10  
 3724408 ..... 10  
 3724409 ..... 10  
 3724410 ..... 10  
 3724411 ..... 10  
 3724420 ..... 43  
 3724421 ..... 43  
 3724422 ..... 43  
 3734107 ..... 14

<sup>(D)</sup> Distributed by Integra MicroFrance SAS (France)





CP934-1 ..... 34  
 CP938-1 ..... 32  
 CP941 ..... 17  
 CP985 ..... 15  
 CP988-15 ..... 34  
 CP1107 ..... 37

**H**

HM75GL-6-0<sup>(D)</sup> ..... 76

**M**

M832 ..... 33  
 M833 ..... 33  
 MCEN23-2-5 ..... 42  
 MCEN23-3-0 ..... 42  
 MCEN136SC ..... 79  
 MCEN770J30 ..... 41  
 MCEN770J40 ..... 41  
 MCO1B ..... 42  
 MCO3PO5 ..... 44  
 MCO3PO7 ..... 44  
 MCO3P10 ..... 44  
 MCO3P12 ..... 44  
 MCO3P15 ..... 44  
 MCO3P18 ..... 44  
 MCO3P20 ..... 44  
 MCO3P24 ..... 44  
 MCO3T-0-5 ..... 66  
 MCO3T-0-7 ..... 66  
 MCO3T-1-0 ..... 66  
 MCO3T-1-2 ..... 66  
 MCO4 ..... 46  
 MCO4A ..... 46, 62, 63  
 MCO4B ..... 46  
 MCO4C ..... 46  
 MCO5 ..... 49  
 MCO5A-1-0 ..... 49  
 MCO5A-1-5 ..... 49  
 MCO5A-2-0 ..... 49  
 MCO5A-2-5 ..... 49  
 MCO5B ..... 49  
 MCO5C ..... 49  
 MCO5D ..... 49  
 MCO5E ..... 49  
 MCO6 ..... 49  
 MCO6A ..... 53  
 MCO6B ..... 53  
 MCO6C ..... 49  
 MCO6M ..... 73  
 MCO7-1 ..... 51  
 MCO7-3 ..... 51  
 MCO7A-1 ..... 51  
 MCO7A-3 ..... 51  
 MCO7A-5 ..... 51

MCO7A6 ..... 51  
 MCO7AMO ..... 73  
 MCO8 ..... 50  
 MCO8B ..... 50  
 MCO8BM ..... 55  
 MCO9 ..... 54  
 MCO9-1 ..... 54, 66  
 MCO10 ..... 49  
 MCO10M ..... 49  
 MCO10MO ..... 73  
 MCO12B ..... 56  
 MCO12D ..... 56, 62  
 MCO12E ..... 56, 62, 63  
 MCO12H ..... 56, 62, 63  
 MCO12R ..... 56  
 MCO13A ..... 5, 45  
 MCO13B ..... 5, 45  
 MCO13C ..... 45, 62, 63  
 MCO13D ..... 5, 45  
 MCO13E ..... 45  
 MCO17 ..... 45  
 MCO21 ..... 46  
 MCO21A ..... 46  
 MCO21D ..... 46  
 MCO21G ..... 46  
 MCO21H ..... 46  
 MCO22 ..... 45  
 MCO23 ..... 45  
 MCO23A ..... 45  
 MCO23B ..... 45  
 MCO25 ..... 48  
 MCO25H ..... 48  
 MCO26 ..... 48  
 MCO27 ..... 47, 62, 63  
 MCO29 ..... 59  
 MCO29-1 ..... 59  
 MCO31 ..... 52  
 MCO32 ..... 52  
 MCO34 ..... 56  
 MCO35 ..... 67  
 MCO36 ..... 67  
 MCO37 ..... 50  
 MCO37-1 ..... 50  
 MCO37D ..... 50  
 MCO37G ..... 50  
 MCO201-2-5 ..... 43  
 MCO201-3-0 ..... 43  
 MCO201-4-0 ..... 43  
 MCO204C ..... 49  
 MCO205 ..... 53  
 MCO205A ..... 53  
 MCO205B ..... 53  
 MCO205C ..... 53  
 MCO205D ..... 53

MCO207-1-5 ..... 51  
 MCO207-2-0 ..... 51  
 MCO213-4 ..... 59, 62, 63  
 MCO214-13-10 ..... 25  
 MCO214-13-20 ..... 25  
 MCO214-13-40 ..... 25  
 MCO214-13-60 ..... 25  
 MCO214-13-80 ..... 25  
 MCO215 ..... 49  
 MCO216-3-5 ..... 50  
 MCO218-4 ..... 59  
 MCO218-6 ..... 59  
 MCO218-8 ..... 59  
 MCO221 ..... 52  
 MCO221A ..... 52  
 MCO221MO ..... 73  
 MCO222 ..... 47  
 MCO224-2-0 ..... 50  
 MCO224A-2-0 ..... 50  
 MCO224G ..... 50  
 MCO226 ..... 53  
 MCO226A ..... 53  
 MCO226B ..... 53  
 MCO226C ..... 53  
 MCO233 ..... 11  
 MCO237 ..... 11  
 MCO240 ..... 50, 66  
 MCO250 ..... 58  
 MCO255 ..... 58  
 MCO270 ..... 47  
 MCO271 ..... 47  
 MCO272 ..... 47  
 MCO290 ..... 55  
 MCO291 ..... 55, 75  
 MCO301 ..... 72  
 MCO302 ..... 72  
 MCO303 ..... 72  
 MCO304 ..... 72  
 MCO305 ..... 15  
 MCO309 ..... 70  
 MCO310 ..... 70  
 MCO311-1-0 ..... 42  
 MCO311-1-2 ..... 42  
 MCO311-1-5 ..... 42  
 MCO311-1-8 ..... 42  
 MCO311-2-0 ..... 42  
 MCO311-2-5 ..... 42  
 MCO311-3-0 ..... 42  
 MCO311-3-5 ..... 42  
 MCO311-4-0 ..... 42  
 MCO312 ..... 49  
 MCO313 ..... 49  
 MCO318 ..... 70  
 MCO319 ..... 70

MCO320 ..... 72  
 MCO330MO ..... 73  
 MCO333 ..... 72  
 MCO337DL ..... 72  
 MCO337DR ..... 72  
 MCO340 ..... 73  
 MCO341 ..... 73  
 MCO342 ..... 73  
 MCO343 ..... 73  
 MCO351 ..... 71, 75  
 MCO352-20 ..... 69  
 MCO352-25 ..... 69  
 MCO352-30 ..... 69  
 MCO352E20 ..... 69  
 MCO352E25 ..... 69  
 MCO352N20 ..... 69  
 MCO352N25 ..... 69  
 MCO353D10 ..... 68  
 MCO354 ..... 68  
 MCO357A ..... 70  
 MCO358 ..... 21  
 MCO366F10 ..... 44  
 MCO366F12 ..... 44  
 MCO366F15 ..... 44  
 MCO366F20 ..... 44  
 MCO367F10 ..... 68  
 MCO367F12 ..... 68  
 MCO367F15 ..... 68  
 MCO367F20 ..... 68  
 MCO368F20 ..... 68  
 MCO368F25 ..... 68  
 MCO551 ..... 61  
 MCO551A ..... 61  
 MCO551B ..... 61  
 MCO571 ..... 57, 62, 63  
 MCO649SC ..... 62, 63  
 MCO650 ..... 49, 62, 63  
 MCO651 ..... 49, 62, 63  
 MCO651F ..... 49  
 MCO652 ..... 49, 62, 63  
 MCO653 ..... 49, 62, 63  
 MCO654-1 ..... 62, 63  
 MCO654-2 ..... 62, 63  
 MCO655 ..... 51, 62, 63  
 MCO656 ..... 54, 62, 63  
 MCO657 ..... 52, 62, 63  
 MCO658 ..... 48, 62, 63  
 MCO660-2 ..... 59, 62, 63  
 MCO660-8 ..... 59, 62  
 MCO660-10 ..... 59, 62  
 MCO660-12 ..... 59, 62, 63  
 MCO661-7 ..... 44, 62  
 MCO661-10 ..... 44, 62, 63  
 MCO662-1 ..... 53, 62, 63

<sup>(D)</sup> Distributed by Integra MicroFrance SAS (France)

MCO662-2 ..... 53, 62  
MCO663-1 ..... 53, 62, 63  
MCO663-2 ..... 53, 62  
MCO664 ..... 53, 62  
MCO665 ..... 53, 62, 63  
MCO666 ..... 52, 62  
MCO667 ..... 50, 62  
MCO670-1 ..... 63  
MCO702-22<sup>(D)</sup> ..... 76  
MCO731<sup>(D)</sup> ..... 77  
MCO770-1-5 ..... 41  
MCO770-2-0 ..... 41  
MCO770-2-5 ..... 41  
MCO770-3-0 ..... 41  
MCO770-3-5 ..... 41  
MCO770-4-0 ..... 41  
MCO770L15 ..... 69  
MCO770L20 ..... 69  
MCO770L25 ..... 69  
MCO770L30 ..... 69  
MCO770L35 ..... 69  
MCO770L40 ..... 69  
MCO771-2-5 ..... 41  
MCO771-3-0 ..... 41  
MCO771-4-0 ..... 41  
MCO772 ..... 42  
MCO773 ..... 43  
MCO774-0-4 ..... 43  
MCO774-0-5 ..... 43  
MCO774-0-6 ..... 43  
MCO774D8 ..... 43  
MCO775-1 ..... 42  
MCO776 ..... 42, 66  
MCO781 ..... 6  
MCO782L ..... 48  
MCO782R ..... 48  
MCO800 ..... 52  
MCO801 ..... 52  
MCO802 ..... 52  
MCO803 ..... 15  
MCO804 ..... 54, 66  
MCO805 ..... 3  
MCO805A ..... 3  
MCO806 ..... 53  
MCO806A ..... 53  
MCO806B ..... 53  
MCO807 ..... 3, 53  
MCO817 ..... 50  
MCO819 ..... 58  
MCO820 ..... 58, 62, 63  
MCO821-1 ..... 78  
MCO823 ..... 60  
MCO824-1 ..... 78  
MCO830 ..... 56

MCO832A ..... 53  
MCO832B ..... 53  
MCO832C ..... 53  
MCO832D ..... 53  
MCO841 ..... 62, 63  
MCO844 ..... 57  
MCO865-1 ..... 76, 78  
MCO866 ..... 67  
MCO890 ..... 43  
MCO890-1-04 ..... 43  
MCO890-1-08 ..... 43  
MCO890-1-12 ..... 43  
MCO890-1-15 ..... 43  
MCO890-1-20 ..... 43  
MCO901 ..... 52  
MCO915 ..... 53  
MCO916 ..... 53  
MCO920 ..... 53  
MCO929 ..... 50, 66  
MCO950 ..... 3  
MCO951 ..... 50  
MCO960 ..... 45  
MCO961 ..... 45  
MCO971T ..... 54  
MCO973T ..... 54  
MCO978 ..... 12  
MCO978S ..... 12  
MCO979 ..... 16  
MCO980 ..... 12  
MCO981 ..... 12  
MCO981D ..... 12  
MCO982 ..... 12  
MCO983 ..... 12  
MCO983-4 ..... 12  
MCO988 ..... 16  
MCO989 ..... 55  
MCO997 ..... 57  
MCOP7A3 ..... 64  
MCOP23A ..... 65  
MCOP23B ..... 65  
MCOP25 ..... 65  
MCOP337A ..... 64  
MCOP347A ..... 64  
MCOP347B ..... 64  
MCOP348A ..... 64  
MCOP348B ..... 64  
MCOP348C ..... 64  
MCOP348D ..... 64  
MCOP366A ..... 65  
MCOP366B ..... 65  
MCOP651 ..... 64  
MCOP820 ..... 65  
MCOR20 ..... 56  
MCOR25 ..... 56

MCOR30 ..... 56  
MCOR35 ..... 56  
MCOR40 ..... 56  
MCOR45 ..... 56  
MCOR50 ..... 56  
MCOR55 ..... 56  
MCOR60 ..... 56  
MCOR65 ..... 56  
MCOR70 ..... 56  
MCOR75 ..... 56  
MCOR80 ..... 56  
MCOS10SC ..... 79  
MCOS14 ..... 74  
MCOS15 ..... 74  
MCOS16 ..... 74  
MCOS17 ..... 74  
MCOS18 ..... 74  
MCOS19 ..... 74  
MCOS20 ..... 74  
MCOS21 ..... 74  
MCOS22 ..... 74  
MCOS23 ..... 74  
MCOS25 ..... 74  
MCOS26 ..... 74  
MCOS27 ..... 74  
MCOS29 ..... 74  
MCOS30 ..... 74  
MCOS31 ..... 74  
MCOS32 ..... 74  
MCOS33 ..... 74  
MCOS34 ..... 74  
MCOS35 ..... 74  
MCOS36 ..... 74

S

SM63<sup>(D)</sup> ..... 8  
SM64<sup>(D)</sup> ..... 8  
SM65<sup>(D)</sup> ..... 8

N

N480G ..... 46

P

P761-7 ..... 38  
P761-8 ..... 38  
P762-2 ..... 39  
P762-4 ..... 39  
P763 ..... 40  
P764-1 ..... 39  
P764-3 ..... 39  
P764-5 ..... 39  
P764-7 ..... 39  
P764-11 ..... 39  
P765-14 ..... 40  
P765-16 ..... 40  
P769 ..... 40

<sup>(D)</sup> Distributed by Integra MicroFrance SAS (France)

### Manufacturers :



Integra MicroFrance SAS (France)  
Le Pavillon ■ 03160 Saint Aubin le Monial ■ France



Medtronic Xomed  
6743 Southpoint Drive N.  
Jacksonville 32216-0980 ■ Florida USA



Medtronic B.V.  
Earl Bakkenstraat 10  
6422 PJ Heerlen  
The Netherlands



FFDM - Pneumat  
78/80 Avenue de la Prospective  
18020 Bourges ■ France



### Manufacturers with CE class I products only :

Agencinox  
Zone Industrielle  
89110 Aillant sur Tholon ■ France



Hager & Meisinger GmbH  
Hansenmannstrasse 10  
D- 41468 Neuss ■ Allemagne



Concorde Import Export  
B.P. 37  
92300 Levallois-Perret ■ France



Swann Morton Ltd  
Penn Works ■ Owlerton Green ■ Sheffield  
South Yorkshire S6 2BJ ■ Royaume Uni



Chemische Fabrik Dr. Weigert GmbH & Co.  
Mühlenhagen  
D-20539 Hamburg ■ Allemagne



Unimed SA  
Rue du Grand-Pré 10  
1007 Lausanne ■ Suisse

Availability of these products might vary from a given country or region to another, as a result of specific local regulatory approval or clearance requirements for sale in such country or region.

- Please read carefully the instructions for use.
- Non contractual document. The manufacturer reserves the right, without prior notice, to modify the products in order to improve their quality.
- Warning: Applicable laws restrict these products to sale by or on the order of a physician.

### Additional information for EMEA Customers only :

Products mentioned in this document are CE class I or IIa devices. Contact Integra should you need any additional information on devices classification. All the medical devices mentioned on this document are CE marked according to European council directive 93/42/EEC on medical devices and its relatives. References that are not medical devices are identified with the indication "NOT MEDICAL DEVICE".

Products marked with the symbol <sup>(®)</sup> are distributed by Integra MicroFrance SAS (France)

Date of last révision : 06/2015

## For more information, please contact customer service :

### Europe, Middle-East, Africa

France / International : +33 (0) 470 67 98 00 ■ +33 (0) 470 67 98 20 (Fax) ■ [microfrance@integralife.com](mailto:microfrance@integralife.com)  
United Kingdom : +44 (0) 1264 312 725 ■ +44 (0) 1264 312 821 (Fax) ■ [custsvckuk@integralife.com](mailto:custsvckuk@integralife.com)  
Germany : +49 (0) 2102 5535 6200 ■ +49 (0) 2102 5536 636 (Fax) ■ [custsvcgermany@integralife.com](mailto:custsvcgermany@integralife.com)  
Benelux: +32 (0)2 257 4130 ■ +32 (0)2 253 2466 (Fax) ■ [custsvcbenelux@integralife.com](mailto:custsvcbenelux@integralife.com)  
[integralife.eu/contact](http://integralife.eu/contact)

Integra and the Integra logo are registered trademarks of Integra LifeSciences Corporation or its subsidiaries in the United States and/or other countries.

MicroFrance is a trademark of Integra LifeSciences Corporation or its subsidiaries.

All other trademarks and product names are the property of their respective owners.

©2015 Integra LifeSciences Corporation. All rights reserved.

Printed in France. 0328571-1-EN

DOCUMENT FOR USE IN EUROPE, MIDDLE-EAST AND AFRICA ONLY.