

Integra[®] MicroFrance[®]
Integra ENT - Throat catalogue

| | | | |
|---|-----|---|----|
| Table of contents | ii | Neck surgery | 16 |
| Ordering and warranty informations | vi | Tracheal dilator | 16 |
| Indications - Contraindications | vii | Round sharp hook | 16 |
| Diagnosis | 2 | Guiding probe | 16 |
| Laryngeal mirror with handle | 2 | Facial nerve dissector | 16 |
| Double tongue depressor | 3 | Shear | 16 |
| Ring tongue depressor | 3 | "S" curved scissors | 16 |
| Mouth-gag frame | 4 | Curved dissector | 16 |
| Palatine blade for mouth gag | 4 | Micro surgery | 17 |
| Dental mouth guard | 5 | Irrigation tube | 17 |
| Mouth gag blade | 6 | Vascular clamp | 17 |
| Mouth-gag | 7 | Approximator | 17 |
| Morinière mouth-gag | 8 | Micro dissecting forceps | 17 |
| Presentation of the mouth-gag | 8 | Jewelers forceps | 17 |
| Composition of the mouth-gag | 9 | Needle-holder | 18 |
| Add-ins | 10 | Micro scissors | 18 |
| Tongue depressor | 11 | Sterilization case | 18 |
| Tongue depressor with suction tube and basket | 11 | Silicone cover | 18 |
| Double tongue depressor with basket | 11 | Elevator - Raspatory | 19 |
| Tonsil adenoid forceps | 12 | Elevator | 19 |
| Tonsil forceps with teeth | 12 | Double elevator | 19 |
| Tonsil haemostatic forceps | 12 | Curved double raspatory | 19 |
| Adenoid forceps | 12 | Scalpel | 20 |
| Tonsil adenoid instruments | 13 | Scalpel handle | 20 |
| Elevator and dissector | 13 | Knives | 20 |
| Monopolar elevator suction tube | 13 | Curved raspatory | 21 |
| Monopolar electrode pick | 13 | Curved raspatory | 22 |
| Double elevator | 13 | Retractor | 23 |
| Elevator | 13 | Double retractor blunt | 23 |
| Blunt curette | 13 | Round sharp hook | 23 |
| Tonsil knife blunt tip | 13 | Blunt retractor | 23 |
| Blunt suction tube | 13 | Sharp retractor articulated | 23 |
| Curved elevator and retractor | 13 | Retractor 2 prongs | 24 |
| Scalpel handle | 13 | Retractor 3 prongs | 24 |
| Adenoid curette | 14 | Retractor 4 prongs | 24 |
| without basket | 14 | Double retractor blunt and 3 sharp prongs | 24 |
| with basket | 14 | Large self-retaining retractor | 25 |
| Tonsil snare, Amygdalotome | 15 | Malleable blade retractor - Double retractor blunt | 26 |
| Amygdalotome, tonsil blade | 15 | Blunt retractor - Double retractor | 27 |
| Amygdalotome, Handle | 15 | Double retractor blunt | 27 |
| Tonsil snare | 15 | Blunt retractor 2 prongs | 27 |
| Snare wire | 15 | Double retractor 2 blunt blades and 4 sharp prongs | 27 |
| Stainless steel wire | 15 | Small scissors, pointed | 28 |

| | | | |
|---|----|---|----|
| Long scissors, pointed | 29 | Stratte needle-holder - Needle-holder scissors | 50 |
| Small scissors, blunt | 30 | Fine haemostatic forceps | 51 |
| Curved scissors blunt tip | 30 | Straight jaws without teeth | 51 |
| Straight scissors blunt tip | 30 | Straight jaws with teeth | 51 |
| Long scissors, blunt | 31 | Curved jaws without teeth | 51 |
| Small Metzenbaum scissors | 32 | Curved jaws with teeth | 51 |
| Curved scissors blunt tip | 32 | Medium haemostatic forceps | 52 |
| Curved scissors blunt tip tungsten blades | 32 | Straight jaws without teeth | 52 |
| Straight scissors blunt tip | 32 | Straight jaws with teeth | 52 |
| Large Metzenbaum scissors | 33 | Curved jaws without teeth | 52 |
| Mayo scissors | 34 | Strong haemostatic forceps | 53 |
| Curved scissors blunt tip | 34 | Towel clamp | 53 |
| Straight scissors blunt tip | 34 | With teeth, «T» tip | 53 |
| Straight scissors pointed blades | 34 | With teeth | 53 |
| Small scissors bayonet blades | 35 | Serrated jaws | 53 |
| Facelift curved scissors serrated bayonet blades | 35 | Grasping forceps | 54 |
| Facelift curved scissors tungsten serrated blades | 35 | Forceps with teeth | 54 |
| Large scissors bayonet blades | 36 | Haemostatic forceps heart serrated jaws | 54 |
| Fine dissecting forceps | 37 | Suction tube with finger control | 55 |
| with teeth and platform | 37 | Esophagoscope | 56 |
| serrated jaws | 37 | Suction tube | 56 |
| with teeth | 37 | Forceps | 56 |
| Adson dissecting forceps | 38 | Esophagoscope | 56 |
| Medium dissecting forceps | 39 | Fiber | 56 |
| Dissecting forceps, 180mm | 41 | Handle | 56 |
| Dissecting forceps, 200mm | 42 | Sterilization case | 56 |
| Medium bipolar dissecting forceps | 43 | Hypopharyngoscope | 57 |
| Bipolar dissecting forceps, 200mm | 44 | Forceps | 57 |
| Irrigation bipolar forceps | 45 | Hypopharyngoscope | 57 |
| Medium monopolar dissecting forceps | 46 | Suction tube | 57 |
| Large monopolar dissecting forceps | 47 | Diverticuloscope | 58 |
| Porte-aiguille mors tungstène | 48 | Suction tube | 58 |
| Tungsten jaws | 48 | Diverticuloscope | 58 |
| Diamond jaws | 48 | Laryngoscope holder, Cold Light | 59 |
| Smooth jaws | 48 | Laryngoscope holder | 59 |
| Tungsten serrated jaws | 48 | Plate for chest holder | 59 |
| Large jaws | 48 | Table | 59 |
| Large tungsten needle-holder | 49 | Operating table clamp | 59 |
| | | Cold light cable | 59 |
| | | Adapter for cold light cable | 59 |
| | | Open laryngoscope | 60 |
| | | Laryngoscope without suction tube | 61 |
| | | Laryngoscope with suction tube | 62 |

| | | | |
|--|----|---|----|
| Sataloff laryngoscope | 63 | Other instruments | 73 |
| Micro suction tube | 64 | Laser guide sleeve | 73 |
| Suction tube | 64 | Laryngeal sprinkler | 73 |
| Blunt eyes suction tube | 64 | Retractor forceps for vocal cord surgery | 73 |
| Insulated suction tube with finger control | 64 | Blunt retractor | 73 |
| Suction tube with finger control | 64 | Needle-holder | 73 |
| Dual suction tube | 64 | Micro coagulation | 74 |
| Sataloff suction tube | 64 | Monopolar electrode pick, bayonet | 74 |
| Bouchayer instruments | 65 | Monopolar suction tube with finger control | 74 |
| Forceps, serrated jaws | 65 | Bipolar forceps | 74 |
| Heart-shaped forceps | 65 | Micro injection | 75 |
| Cup forceps | 65 | Injection pistol | 75 |
| Cup forceps, oval jaws | 65 | Luer-lock US adapter | 75 |
| Micro scissors - Knives | 66 | Bayonet injection needle | 76 |
| Sickle knife | 66 | Straight injection needle | 76 |
| Lancet knife | 66 | Straight malleable injection needle | 76 |
| Lancet knife, handle and 3 blades | 66 | Oro-tracheal injector | 77 |
| Scalpel handle and blades | 66 | Injection needle Oro-tracheal | 77 |
| Laryngeal scissors | 66 | Henry set - 3.0mm | 78 |
| Micro elevator, 320mm | 67 | Fenestrated forceps | 78 |
| Abitbol instruments | 68 | Forceps, alligator jaws | 78 |
| Insulated suction tube with finger control | 68 | Scissors | 78 |
| Monopolar forceps with suction | 68 | Trocar | 78 |
| Sataloff Instruments | 69 | Trocar holder ring | 78 |
| Knife | 69 | Monopolar hook | 78 |
| Ball dissector | 69 | Round probe | 78 |
| Spatula | 69 | Terris set | 79 |
| Retractor | 69 | Double retractor | 79 |
| Mirror | 69 | Curved elevator | 79 |
| Tenotome probe | 69 | Peanut holder | 79 |
| Curved curette for cyst | 69 | Malleable suction tube elevator | 79 |
| Angled handle | 69 | Malleable nerve suction with finger control | 79 |
| Cup forceps | 70 | | |
| Heart-shaped forceps | 70 | | |
| Forceps, serrated jaws | 70 | | |
| Container | 71 | | |
| Benninger instruments | 72 | | |
| Scissors | 72 | | |
| Cup forceps | 72 | | |
| Heart-shaped forceps | 72 | | |
| Forceps, serrated jaws | 72 | | |
| Needle-holder | 72 | | |
| Knot pusher | 72 | | |

| | |
|--|----|
| Mini invasive instrumentation 3.5mm diameter | 80 |
| Monopolar hook | 80 |
| Retractable knife | 80 |
| Suction irrigation tubes | 80 |
| Bipolar forceps | 81 |
| Monopolar forceps | 81 |
| Monopolar scissors | 81 |
| Needle-holder | 81 |
| De Lagausie monopolar instruments | 82 |
| Reinberg needle-holder | 82 |
| Trocar 3,5mm diameter | 83 |
| Trocart tip | 83 |
| Head of trocar | 83 |
| Valve for head of trocar | 83 |
| Sleeve | 83 |
| Sealing cap | 83 |
| Sterilization case, Stainless steel cup, Tray, Surgical oil | 84 |
| Plastic sterilization case | 85 |
| Large plastic sterilization case | 86 |
| Numerical INDEX | 88 |

Pricing :

Prices stated in specific written quotations are firm for thirty days from the date given, and are otherwise subject to change without prior notice. Pricing terms stated on written agreements are governed by such agreements.

Minimum Order Requirements :

The minimum ordering amount is €250 (Integra reserves the right to apply €20 handling fees and transport fees for any order below €250). For partial unit orders, please contact the customer service to obtain a quote.

Administrative fees :

Administrative fees may be charged for any order.

Ordering Procedure :

A written purchase order is required for the purchase of Integra MicroFrance® products.

Acceptance of Orders :

Orders are accepted upon approval by Integra Customer Service.

Return Policy :

- Authorization from Customer Service must be obtained prior to returning product.
- Sterile product must be returned in unopened, undamaged cartons, packed to prevent damage.
- Non-sterile product must be returned in unused saleable condition in original package.
- No credit will be issued for special orders.
- A credit note will be issued for products returned less than ninety days from shipment date with a 20% restocking fee, provided that the product being returned is not damaged and it is possible to verify that the product has not been used or opened.

Integra Limited Warranty

Please refer to the warranty included in the packaging of each product to know the applicable warranty.

Contact Customer service :

France / International

+33 (0) 470 67 98 00
+33 (0) 470 67 98 20 (Fax)
microfrance@integralife.com

Benelux

+32 (0) 2 257 4130
+32 (0) 2 253 2466 (Fax)
custsvcbenelux@integralife.com

United Kingdom

+44 (0) 1264 312 725
+44 (0) 1264 312 821 (Fax)
custsvcuk@integralife.com

Germany

+49 (0) 2102 5535 6200
+49 (0) 2102 5536 636 (Fax)
custsvcgermany@integralife.com

MicroFrance® ENT Instrumentation

INDICATIONS

- All the medical devices showed in this catalogue have indications for diagnosis and/or ENT surgery.
- Sizes are not contractual and are given for information purposes only.

CONTRAINDICATIONS

- Do not use in indications other than the indications mentioned in the DFU or Labeling.

How to read the catalogue

Title and/or product family

Consultation

INTEGRA
LIMIT UNCERTAINTY

Marquet Day Legent

90° 90° 90° 45°

Micro crochets mousse 90° Micro crochets mousse 45° Porte-coton Sonde stylet

| | | | | | | | | | |
|---------|-------|--------|-------|---------|-------|--------|-------|--------|------|
| 160mm | | 150mm | | 160mm | 140mm | 110mm | | | |
| MCD805 | 2,0mm | MCD950 | 0,8mm | 3124027 | 1,0mm | MCD807 | 1,0mm | 7719-2 | 7711 |
| MCD804A | 2,5mm | | | 3124028 | 2,0mm | | | | |
| | | | | 3124029 | 2,5mm | | | | |

Document destiné à l'Europe, au Moyen-Orient et à l'Afrique.



3

Explanation of the table reference and complementary product description

| Title or subtitles | |
|----------------------------------|----------------------------|
| global complementary description | |
| Product Ref.1 | complementary description1 |
| Product Ref.2 | complementary description2 |

Laryngeal mirror with handle

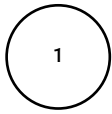
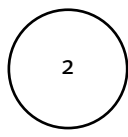
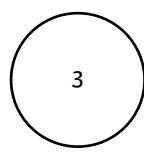
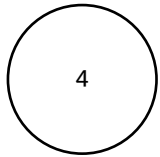
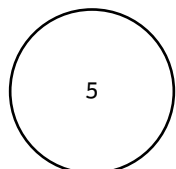
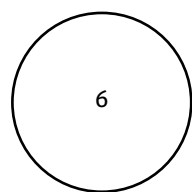
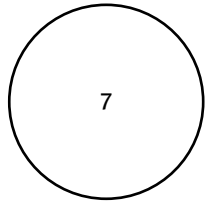
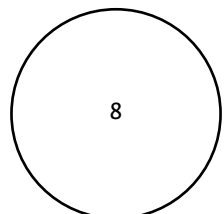
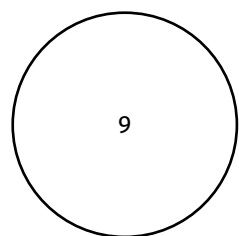

| | | | |
|----------------|---|--|---|
| |  |  |  |
| | 8mm | 10mm | 12mm |
| | 3734048 | 3734049 | 3734050 |
| |  |  |  |
| | 14mm | 16mm | 18mm |
| | 3734051 | 3734052 | 3734053 |
| |  |  |  |
| | 20mm | 22mm | 24mm |
| | 3734147 | 3734054 | 3734055 |
| |  |  |  |
| 170mm | 26mm | 28mm | 30mm |
| 3734057 | 3734056 | 3734057 | 3734058 |

Check



Double

155mm

3714450

Doyen



Double

150mm - Pack 10

7798T^(D)

Doyen



Double

150mm - Pack 10

7798T1^(D)

Tongue depressor

Canuyt



Ring tongue depressor

185mm

7796

^(D) Distributed by Integra MicroFrance SAS (France)

Mac-Ivor



3734152



Kilner

Palatine blade

7803B

7803C

Scale 2/3

April

Davis-Boyle



Dental mouth guard
7802P
Pack 2



MCL200

MCL200

Left

MCL201

Right



7802C

Scale 1/2

Chabolle



- 150mm
- 40x80mm
- MCR2A
- 40x90mm
- MCR3A

Dingmann

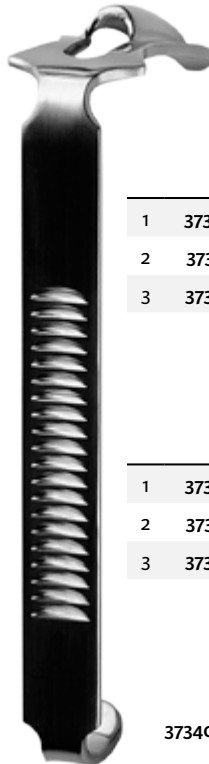

Dingmann

| | | |
|---|---------|---------|
| 1 | 3734060 | 24x52mm |
| 2 | 3734061 | 28x55mm |
| 3 | 3734062 | 30x68mm |

Mac-Ivor

| | | |
|---|---------|----------|
| 1 | 3734066 | 23x74mm |
| 2 | 3734067 | 25x90mm |
| 3 | 3734068 | 26x100mm |

Davis



| | | |
|---|---------|----------|
| 1 | 3734075 | 20x36mm |
| 2 | 3734077 | 24x69mm |
| 3 | 3734079 | 25x83mm |
| 4 | 3734081 | 26x95mm |
| 5 | 3734082 | 27x112mm |

Kilner



Davis-Boyle



Masson

140mm

7809MF



Scale 1/2

Doyen

7821B 120mm

7821A 140mm

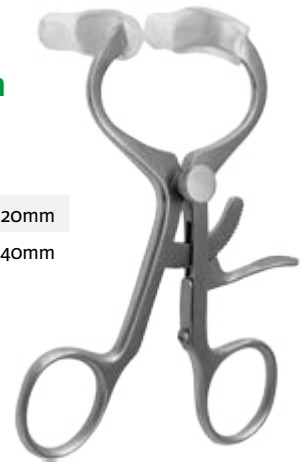

7821B

Seemann-Seiffert



7805-11

7805-11 11mm 160mm

7805-13 13mm 180mm

Jennings

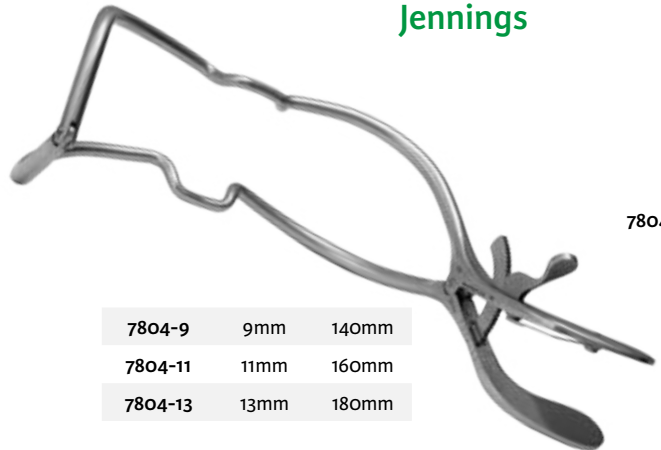

7804-13

7804-9 9mm 140mm

7804-11 11mm 160mm

7804-13 13mm 180mm

Dingmann

3734059

with 3 blades



Denhardt



30mm

3734151

Presentation of the mouth-gag mini-invasive surgery

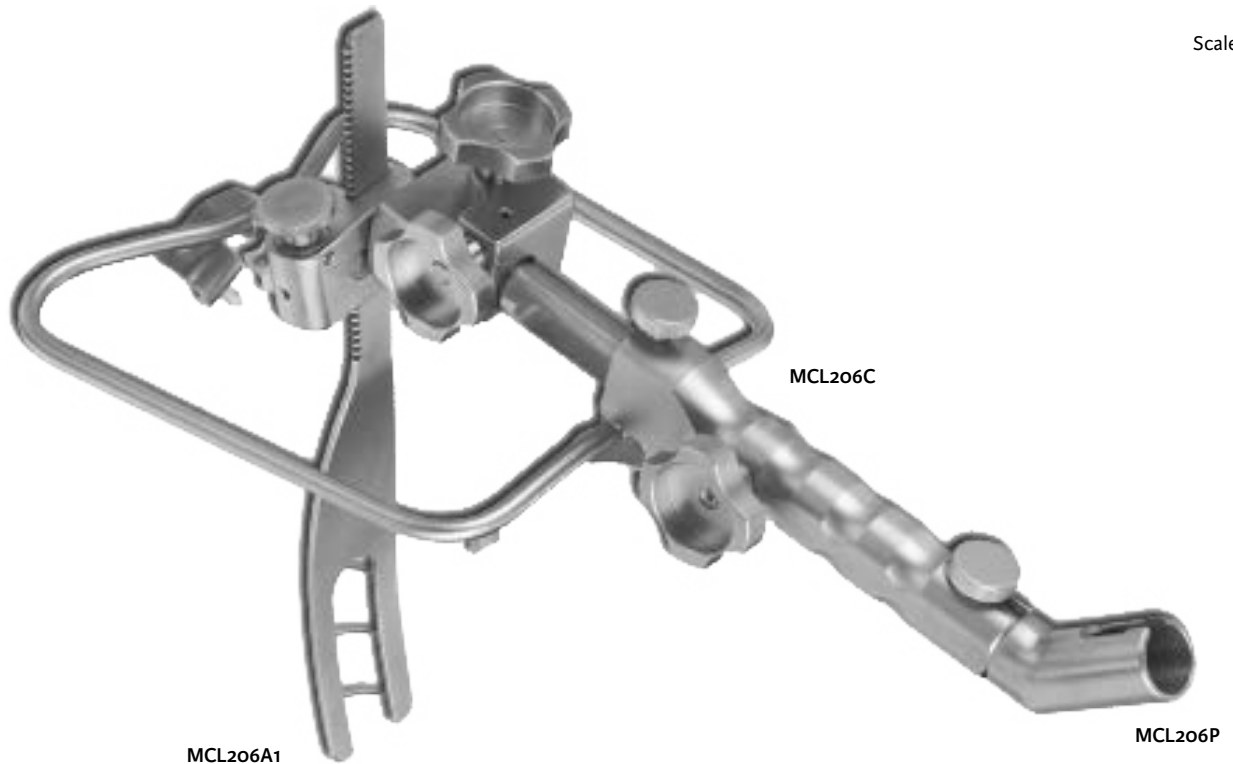

Scale 1/2

Mouth-gag frame MCL206C
with blade MCL206A1
and adapter MCL206P

Composition of the mouth-gag

Frame

Scale 1/3

MCL2o6C

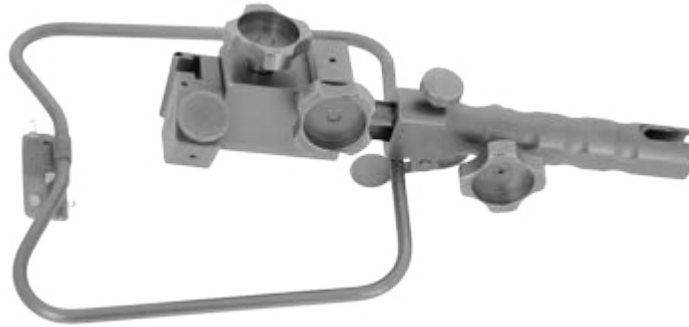

Blades

MCL2o6A1 35x120mm fenêtré



MCL2o6A2 35x120mm



MCL2o6A3 35x110mm



MCL2o6A4 40x85mm



MCL2o6A5 35x65mm



Tightening key

MCL2o6K



Adapter

MCL2o6P



Add-ins

Photos for illustration purposes, unscaled

Dental mouth guard

| | |
|------------------------|---|
| 7802P | Dental mouth guard (Pk 2) |
| 7960T40 ^(D) | Single use dental mouth guard (Pk 40) Sterile |



Cold light

| | |
|-----------------------|-------------------------|
| MCL38N ^(D) | Cold light cable 2200mm |
|-----------------------|-------------------------|

Adapter for light fiber

| | |
|--------------------------|--------------|
| MCL170 ^{(D)(t)} | Wolf |
| MCL171 ^{(D)(t)} | |
| MCL173 ^{(D)(t)} | Storz |
| MCL174 ^{(D)(t)} | |

| | |
|--------------------------|----------------|
| MCL197 ^{(D)(t)} | Olympus |
|--------------------------|----------------|



(t) Not a MEDICAL DEVICE

Light fiber

| | |
|---------|-------------|
| MCL89-2 | Light fiber |
|---------|-------------|

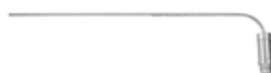

Laryngoscope arm holder

| | |
|-------|-------------------------|
| MCL76 | Laryngoscope arm holder |
|-------|-------------------------|



| | |
|-------|-------|
| MCL35 | Plate |
|-------|-------|

Suction tube

| | |
|---------|-------------------------|
| MCL89-1 | Suction tube |
| MCL100 | Blunt eyes suction tube |



Container

| | |
|-----------|---|
| 7874MF-34 | Sterilization case 380x205x85mm 340x200x80mm |
|-----------|---|



Silicone cover

| | |
|---------|----------------|
| MCM25-3 | Silicone cover |
|---------|----------------|

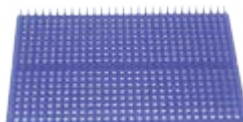

^(D) Distributed by Integra MicroFrance SAS (France)

Portmann



203mm

7857

Wieder



3734093

3734092

30mm

3734093

35mm

Lecouteur



160mm

7800MF

Le Mée



7797-2

170mm

7797-1

Petit

7797-2

Grand

Scale 1/2

Birkett



200mm

7823

Schmidt



190mm

7822

Négus



200mm

7825

White



240mm

3731007

Bourgeois



200mm

7819

Portmann



200mm

7820

Chatelier

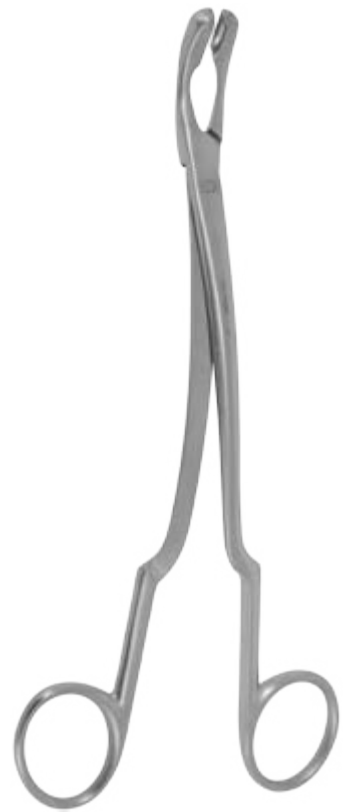

210mm

7826-1-7

Scale 1/2

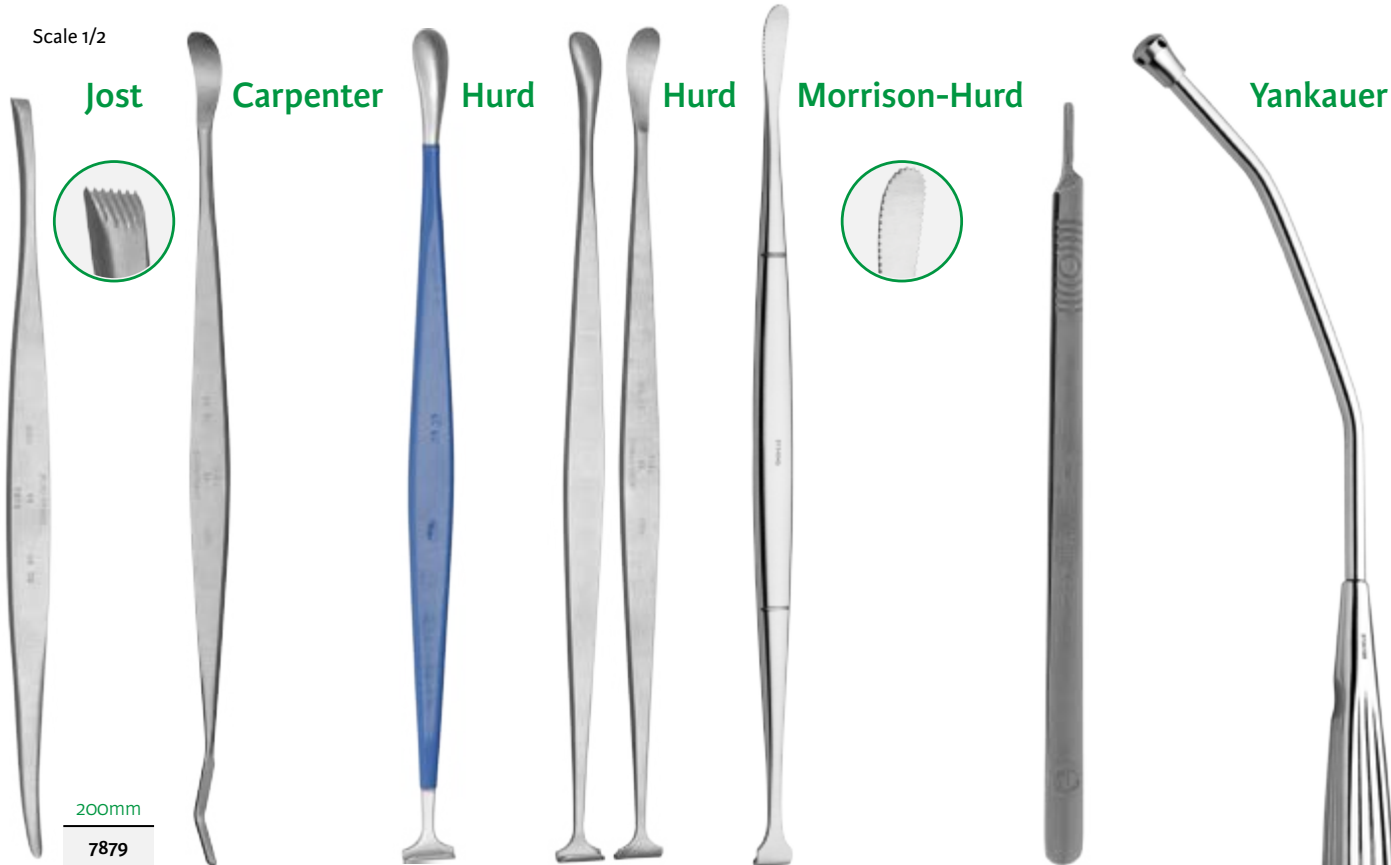

200mm
7879

220mm
7815

220mm
7814M

220mm
7814

225mm
3734045

200mm
1003LI^(D)
blades 10/15

290mm
3734155
6mm



Blondiau

230mm
7812

15x20mm



Ruault

210mm
7811



Léroult

200mm
7884

5mm



220mm
7895

Monopolar cables
4,5 m



CP391E
Erbe Storz Wolf



CP391M
Aesculap Berchtold
Martin Erbe T Serie
Lamidey



CP391V
Bowa Emc Lamidey
Valleylab

^(D) Distributed by Integra MicroFrance SAS (France)

Scale 1/2

Moure

220mm

| | | |
|--|-----------|---------|
| | 7828-1-10 | 6/10mm |
| | 7828-1-13 | 8/13mm |
| | 7828-1-16 | 10/16mm |
| | 7828-1-19 | 12/19mm |



7828-1-13

Moure

220mm

| | | |
|--|---------|---------|
| | 7828-10 | 6/10mm |
| | 7828-13 | 8/13mm |
| | 7828-16 | 10/16mm |
| | 7828-19 | 12/19mm |



7828-16

Barnhill

215mm

| | | |
|---|---------|------|
| 0 | 3734003 | 10mm |
| 1 | 3734004 | 12mm |
| 2 | 3734005 | 14mm |
| 3 | 3734006 | 16mm |
| 4 | 3734007 | 18mm |



3734007

Stubbs

220mm

| | | |
|---|---------|------|
| 0 | 3734131 | 11mm |
| 1 | 3734132 | 14mm |
| 2 | 3734133 | 16mm |
| 3 | 3734134 | 18mm |



3734134

Lermoyez

220mm



| | |
|---------|---------|
| 7829-10 | 5/10mm |
| 7829-13 | 7/13mm |
| 7829-16 | 9/16mm |
| 7829-19 | 13/19mm |



7829-10

Scale 1/2

Working length «L»

Sluder

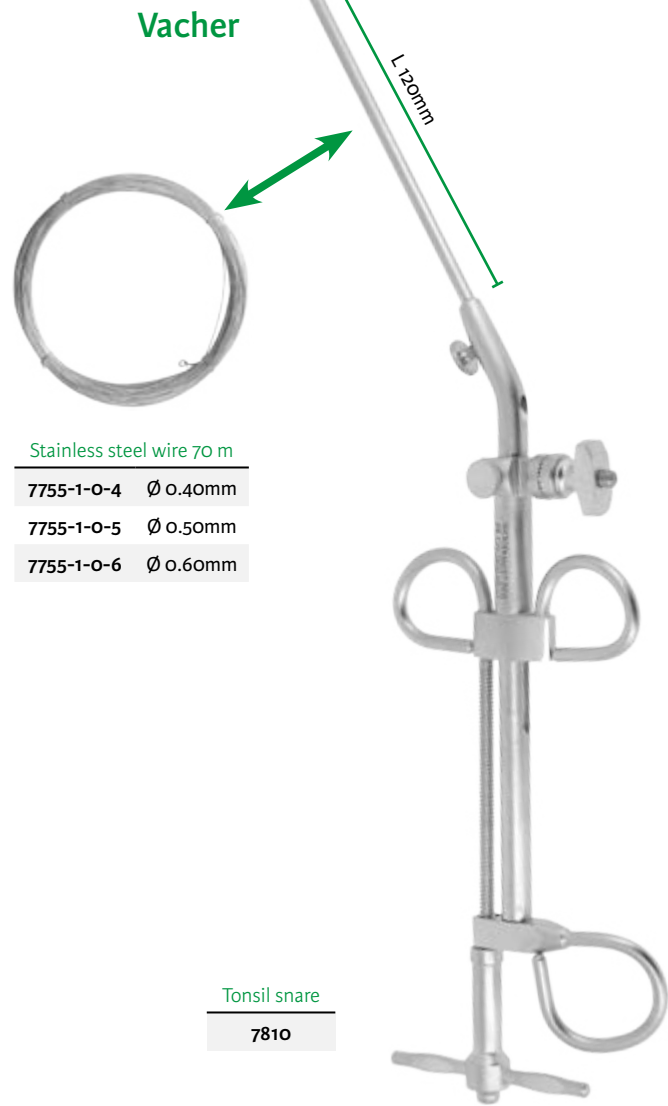
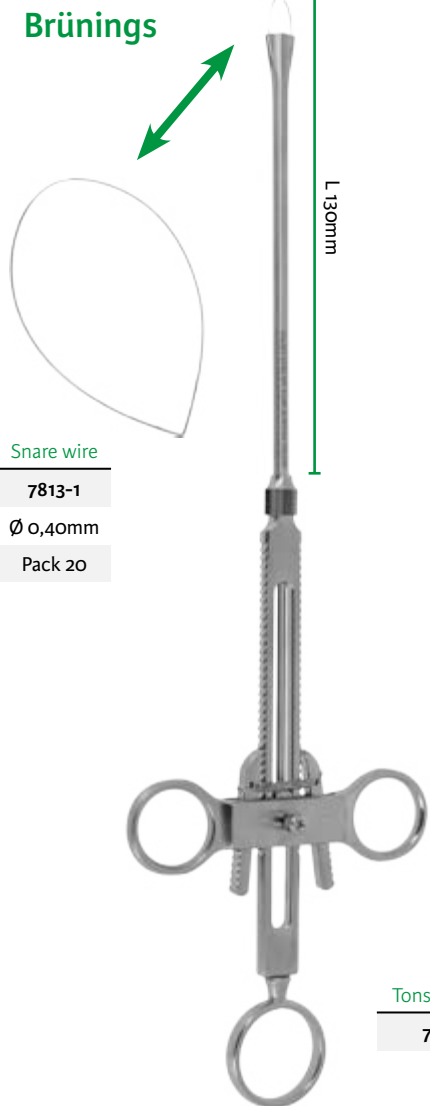
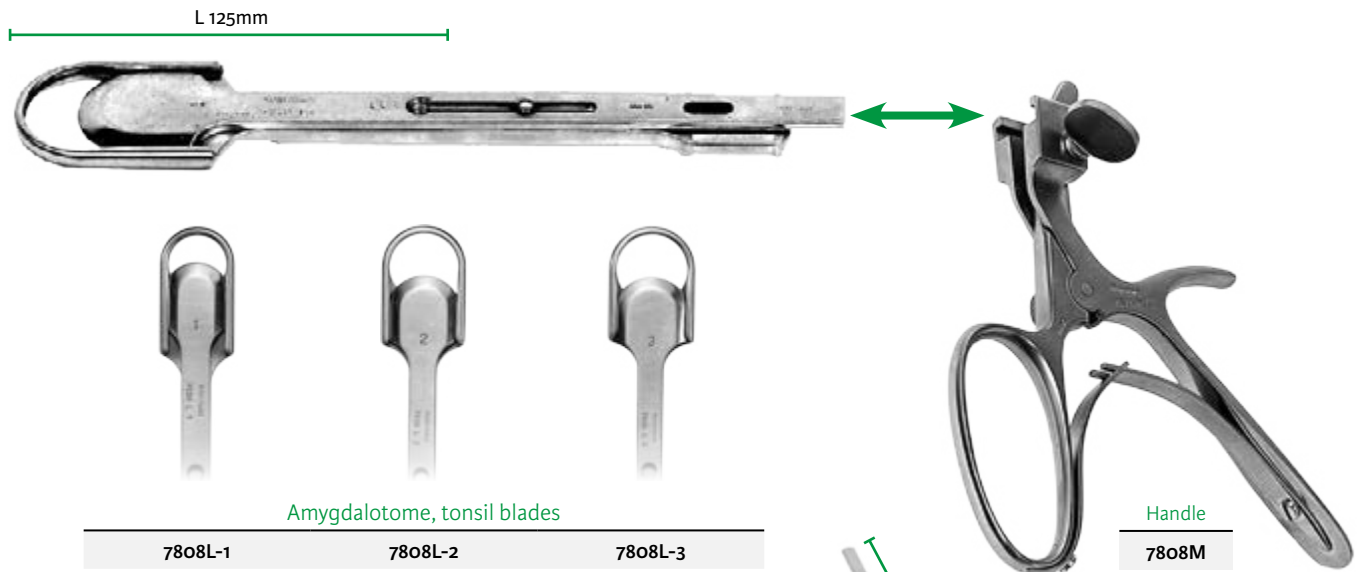

Trousseau



150mm
3734167

Laborde



Tracheal dilator

155mm
3734168

Laborde



120mm
7840

Guerrier



Round sharp hook

180mm
7838

Scale 1/2



Guiding probe

145mm
7839

Facial nerve dissector

160mm
7830M

Moure



Shear

200mm
7835

Guerrier



"S" curved scissors

180mm
7921

Mixer-Baby



140mm
3755129

O'Shaugnessy



Curved dissector

180mm
7837-18

Redon



140mm
7920

Working length «L»

Irrigation tube

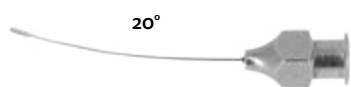

20°
MCM10-0-5 Ø 0,5mm L 30mm
MCM10-1-0 Ø 1,0mm

Vascular clamp



MCM9^(D)
30mm

Approximator - 55mm



Large

MCM13 L 13mm

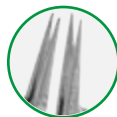

Small

MCM13-1 L 13mm

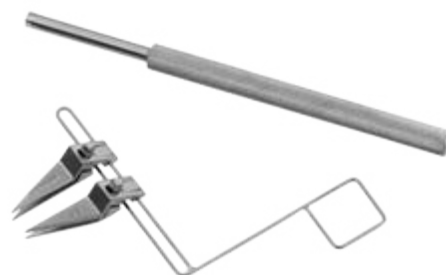

MCM13
with screwdriver

Gilbert O'Brien

Micro dissecting forceps - 150mm



MCM4BISR

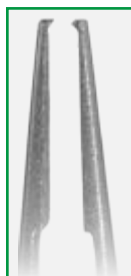

MCM4BISR
Teeth and platform

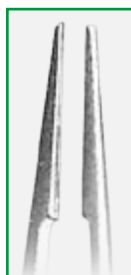

MCM4R
Smooth jaws with plate

Jewelers forceps



130mm

MCM973D3 n°3 3740068 n°1



120mm

3740069 n°3



110mm

3740071 n°5



110mm

3740072
Angled jaws

^(D) Distributed by Integra MicroFrance SAS (France)

Micro scissors

Needle-holder

Vanas



MCM7BISR

8,0mm
blunt curved

Vanas



MCM7R

8,0mm
straight serrated blades



MCM970

8,0mm
Atraumatic curved



MCM7BISR
150mm

O'Brien



MCM12R

5,0x0.30mm
smooth curved jaws

Barraquer-Comtet



MCM1R

8,0mm
smooth straight jaws



MCM12R
150mm

Castroviejo



3752011

10,0mm
smooth curved jaws

Castroviejo



3752008

10,0mm
smooth straight jaws

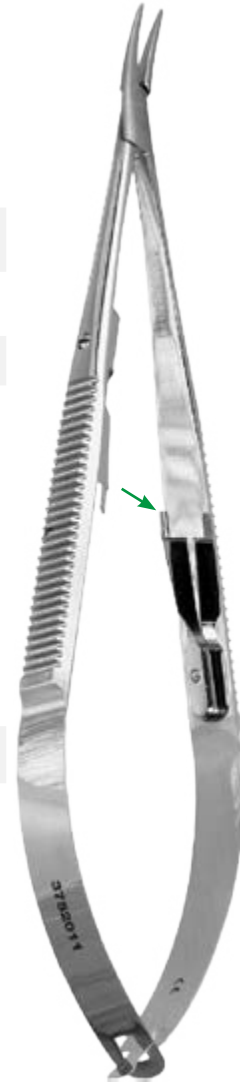

with ratchet
3752011
140mm



MCEN136SC

290x175x55mm - 270x160x35mm

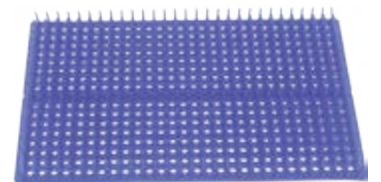

MCM25-3

210x130mm

Lempert



160mm

3714115

2,0mm

3714116

3,0mm



190mm

CP985

5,0mm

Sébileau



180mm

MCO305

8,5mm

Freer



160mm

MCO803

2,5mm

Fleury



185mm

CP611

5,0mm

Howarth



220mm

CP625

Cottle



220mm

CP626

McKenty



240mm

CP627

Scalpel



| | |
|--------|-------|
| CP821B | 100mm |
| CP821C | 130mm |
| CP821D | 150mm |
| CP821E | 190mm |

Lames 11/15

23

SM63^(D) SM64^(D) SM65^(D)

^(D) Distributed by Integra MicroFrance SAS (France)

Heavy



195mm

3724059

6,5mm

Farabeuf



150mm

7787-10

10mm

Fleury



170mm

MCO979

6,5mm

Sébileau



150mm

CP825

4,0mm

Plester



180mm

MCO988

7,5mm

Joseph



180mm

CP310D

5.0mm
straight

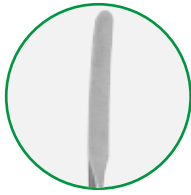

180mm

CP310E

4.0mm



180mm

CP310

5,0mm

Obwegeser

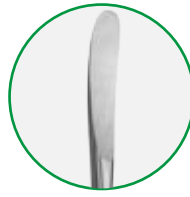

180mm

CP344B

7,0mm



180mm

CP344C

11,0mm

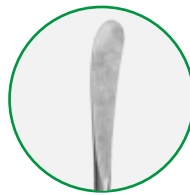

190mm

CP344D

7,0mm



190mm

CP344E

7,0mm



180mm

CP344A

5,0mm

Obwegeser-Tessier

Sharp



180mm

CP344BT

7,0mm



180mm

CP344CT

11,0mm



190mm

CP344DT

7,0mm



190mm

CP344ET

7,0mm



180mm

CP344AT

5,0mm

Army navy



210mm

3714018

Farabeuf



140mm

7768-1

120mm

7768

Desmarres



140mm

CP822-12

12mm

CP822-10

10mm

CP822-14

14mm

Gillies



180mm

CP17

3,0mm

CP17-1

2,0mm

Gillies



145mm

CP17-3

2,0mm

CP17-2

3,0mm



145mm

CP628

5,0mm

Humby



110mm

CP941

Knapp

Blair

Guthrie

Volkman

Senn-Miller



150mm

3714027

8,0mm

3714028

Blunt

140mm

3714184

140mm

CP21-3

Sharp

CP21A-3

Blunt

130mm

3714044

2,0mm

150mm

7782-1-2

180mm

CP335

160mm

CP609

3 sharp prongs

3714032

3 blunt prongs

Weitlaner

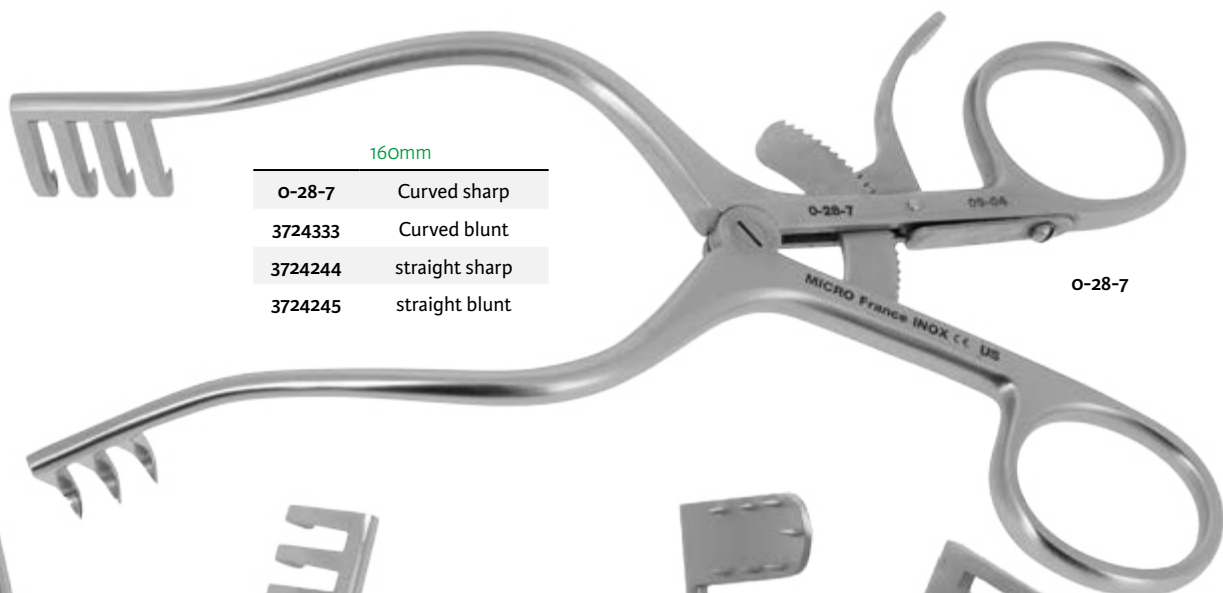

160mm

| | |
|---------|----------------|
| 0-28-7 | Curved sharp |
| 3724333 | Curved blunt |
| 3724244 | straight sharp |
| 3724245 | straight blunt |

0-28-7



Weitlaner-Beckmann

165mm

| |
|------|
| 7781 |
|------|

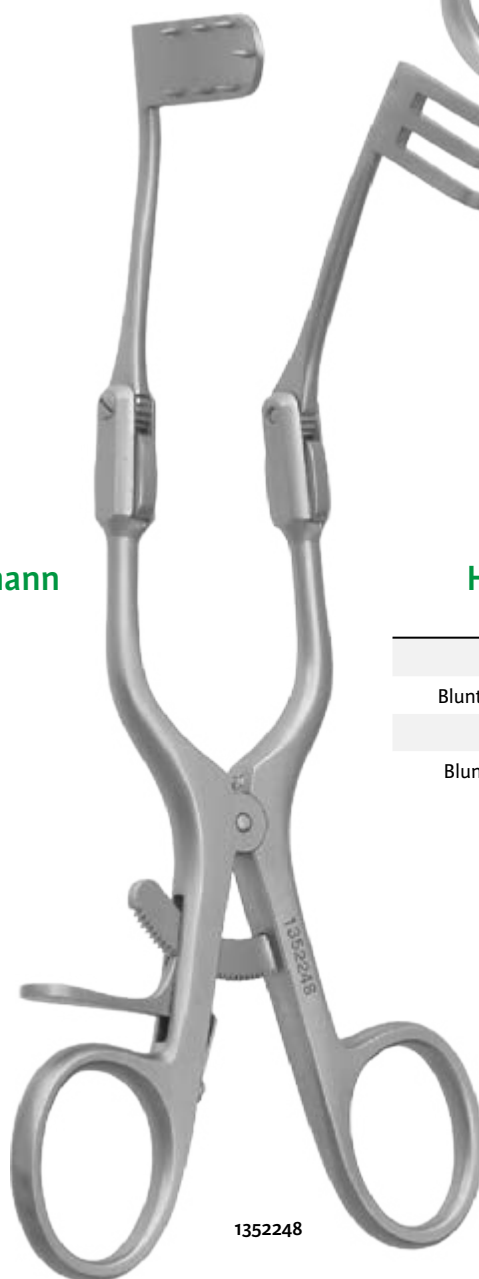

House

165mm

| |
|--------------------|
| 1352248 |
| Blunt prongs right |
| 1352247 |
| Blunt prongs left |

1352248

Malleable

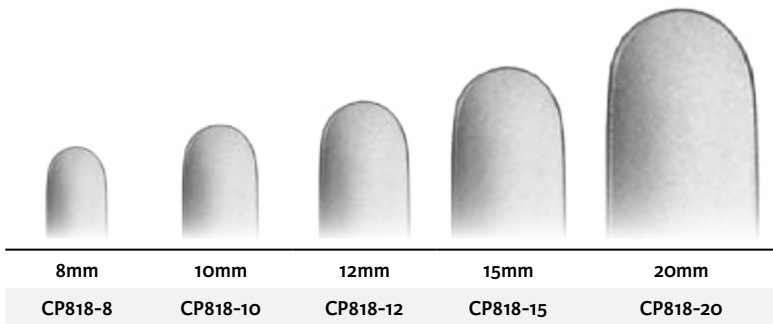

Malleable

10mm



15mm

Dautrey



15x40mm

15x55mm

Dautrey



15x60mm

15x85mm



210mm

CP818-8

140mm

CP984

140mm

CP984-1

160mm

7773

Scale 2/3



CEV418

200mm - Pack 2



Descottes

CEV417

200mm - Pack 2

Mosnier

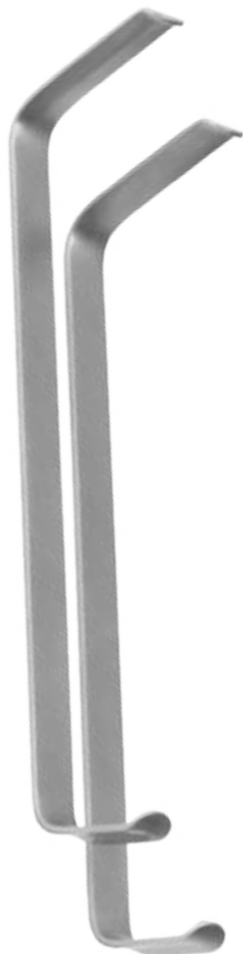

160mm

CEV419

Pack 2

Pessey



180mm

CP335P

Leroux-Robert



160mm

7923

Pack 2



105mm

CP353

Offret

105mm

CP356



Streiff

105mm

CP16-1 Curved blades

CP16 Straight blades



Joseph

120mm

CP354A Curved blades

CP354 Straight blades

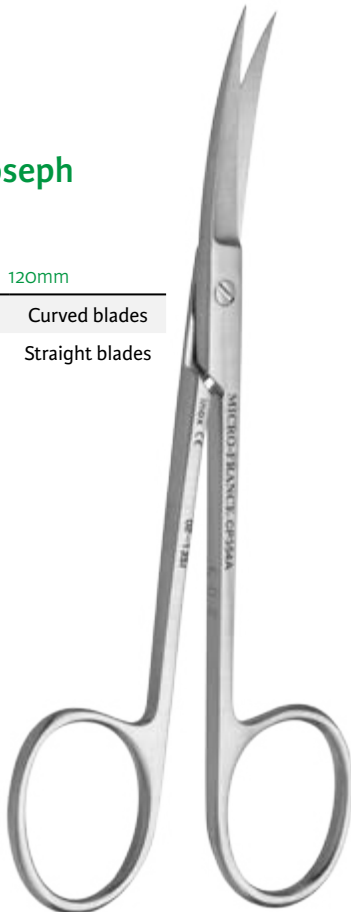

Joseph

110mm

CP919A Curved blades

CP919 Straight blades



Fox

110mm

CP358A Curved blades

CP358 Straight blades

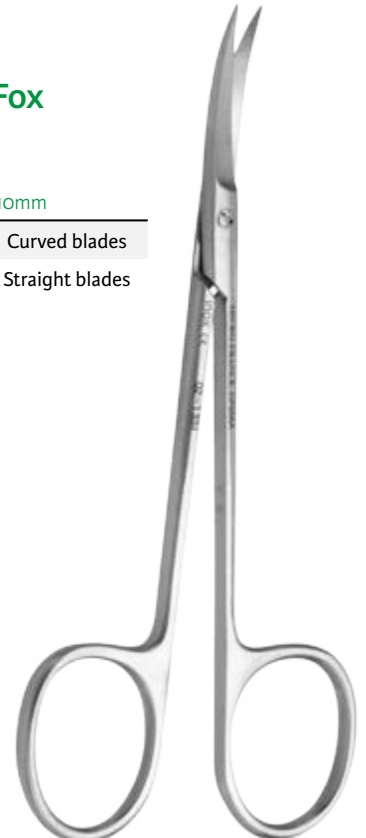

Kilner-jost



120mm

CP362

Curved

Boetcher



180mm

CP997

Curved

Brophy



150mm

CP367-1

CP367

Curved

Straight

Joseph



150mm

CP355A

CP355

Curved

Straight

Shea

120mm

CP637

Curved blades



Stevens

115mm

CP922B

Curved blades



Bregat

110mm

CP363

Curved blades



Stevens

110mm

CP922A

Curved blades

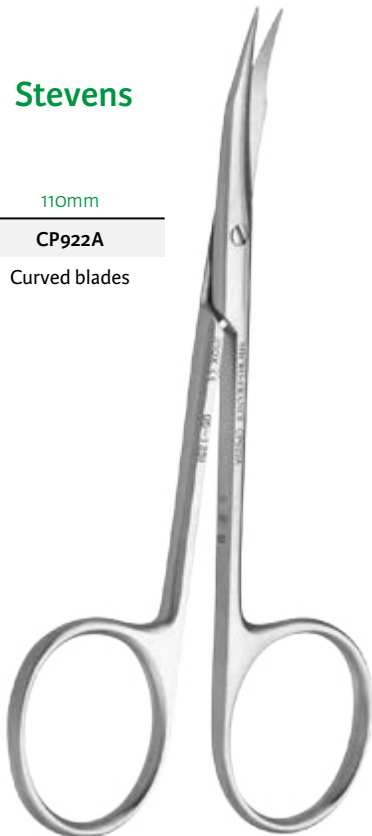

Stevens

110mm

CP922

Straight blades



Ragnell



150mm

CP616-15

Curved

Léger



150mm

CP365

Curved

Reynolds

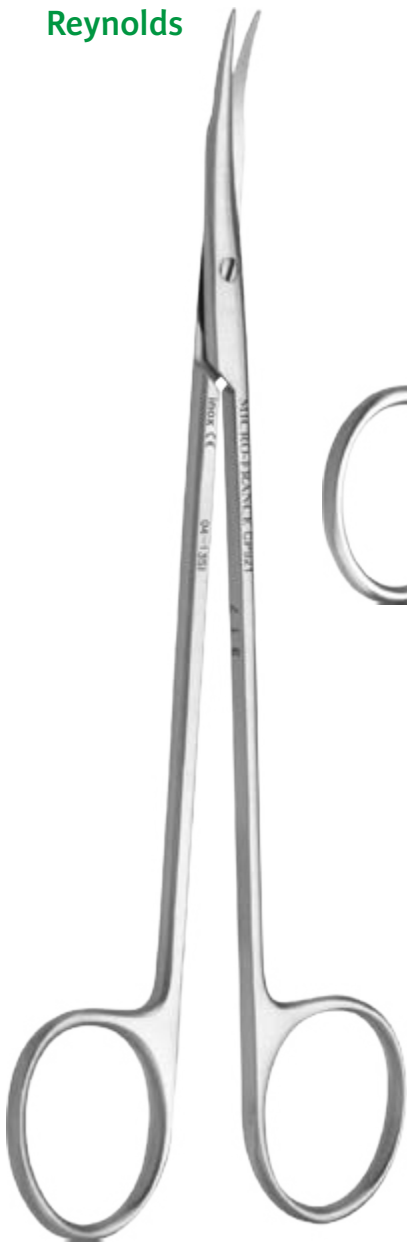

160mm

CP921

Curved

Joseph



150mm

CP355C

Curved

130mm

CP616-13

Curved

Metzenbaum

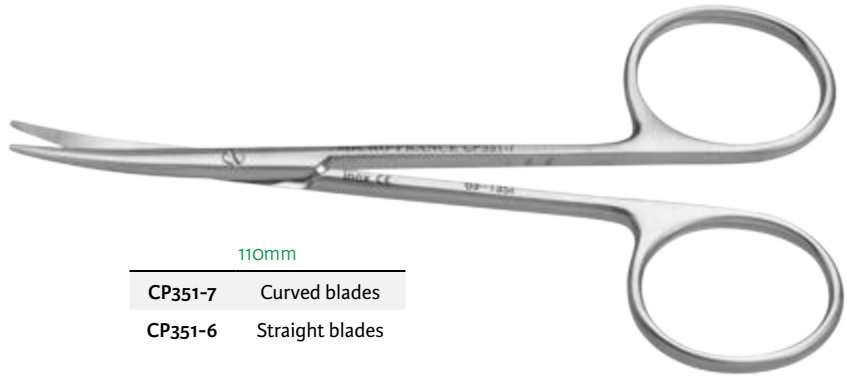

110mm

| | |
|---------|-----------------|
| CP351-7 | Curved blades |
| CP351-6 | Straight blades |

Delicate scissors



150mm

| | |
|---------|-----------------|
| CP931-1 | Curved blades |
| CP931 | Straight blades |

Tungsten blades



150mm

| | |
|---------|-----------------|
| CP351-3 | Curved blades |
| CP351-2 | Straight blades |



150mm

| | |
|---------|-----------------|
| 3741065 | Curved blades |
| 3741071 | Delicate blades |

Fine

Standard

Standard

Fine

Standard

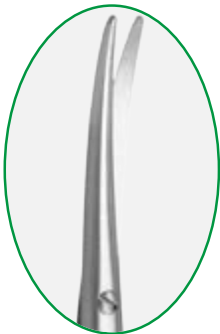
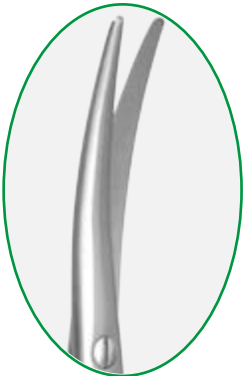

200mm

CP931-5

Curved

180mm

CP931-3

Curved

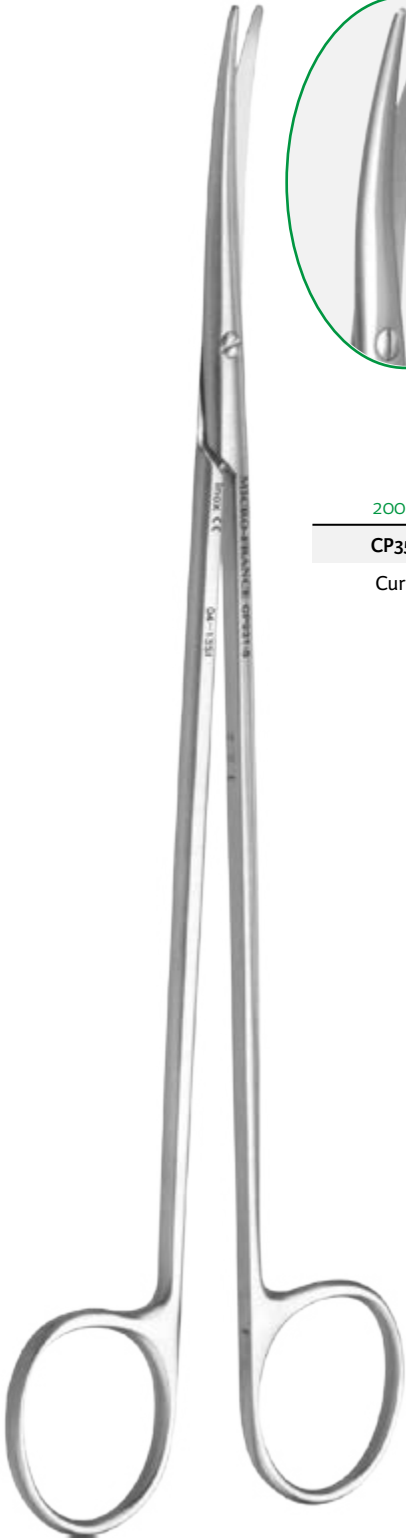

200mm

CP931-5

Curved

180mm

CP351-1

Curved - standard

Curved - Tungsten blades

180mm

230mm

3741067

3741075

Mayo

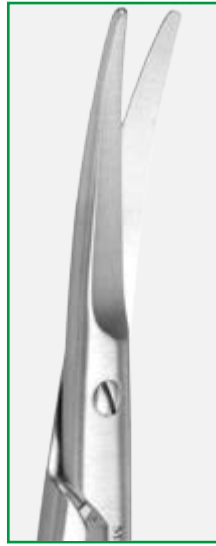

CP352-1

Mayo-Stille



CP352-3



3741057



3741080

| Mayo | 150mm | 170mm |
|-----------------|---------|---------|
| Curved blades | CP352-1 | CP352-3 |
| Straight blades | CP352 | CP352-2 |

| 150mm |
|---------------------------------|
| 3741057 |
| Scissors, sharp straight blades |

| Mayo-Stille | 150mm | 170mm |
|-----------------|---------|---------|
| Curved blades | 3741080 | 3741082 |
| Straight blades | 3741081 | 3741083 |

Tessier

Kaye

Kaye



160mm

CP914

Curved



120mm

CP364

Curved



150mm

3741011

Curved - serrated blades

Serrated blades



Tungsten
serrated blades

115mm

3741017

Curved
tungsten serrated blades

Gorney

Kaye

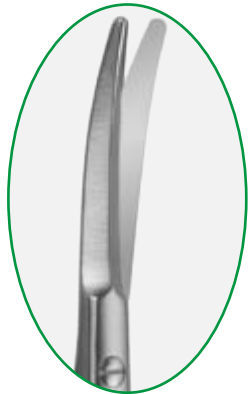
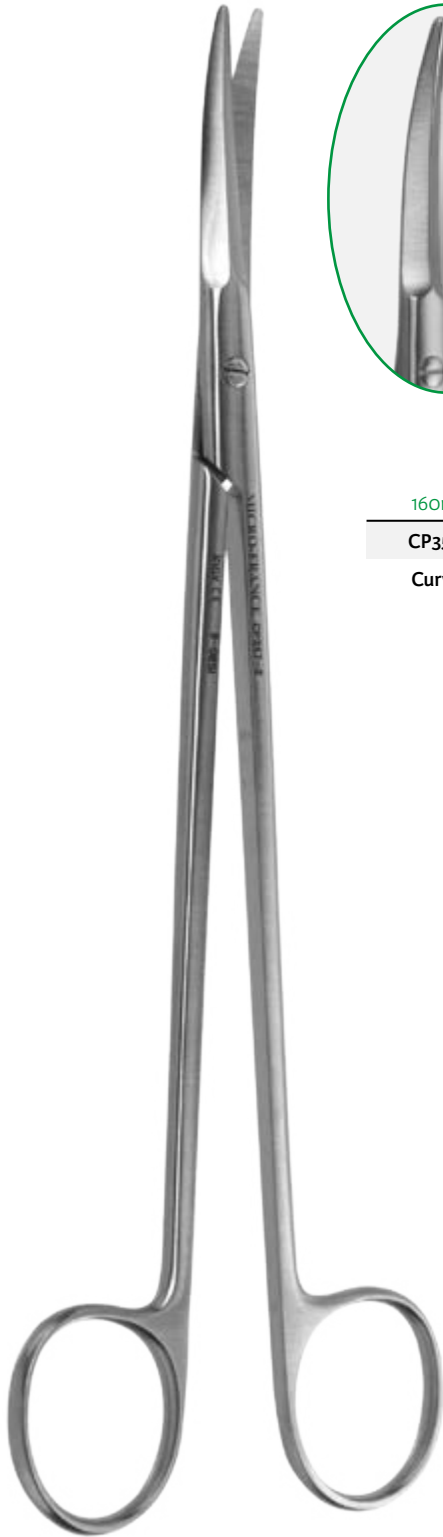

160mm

CP357-1

Curved

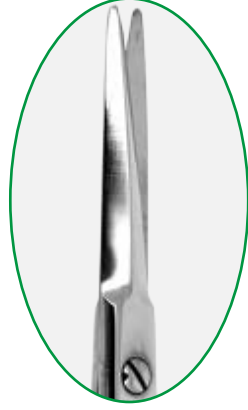

190mm

3741015

Straight



Tungsten
serrated blades

180mm

3741019

Curved

Tungsten serrated blades

200mm

CP357-2

Curved

190mm

3741016

Curved

Dissecting forceps with teeth and platform



110mm
CP37
Oblique teeth and platform

110mm
CP938-1
Horizontal teeth and platform

Castroviejo

Dissecting forceps serrated jaws

Dissecting forceps with teeth

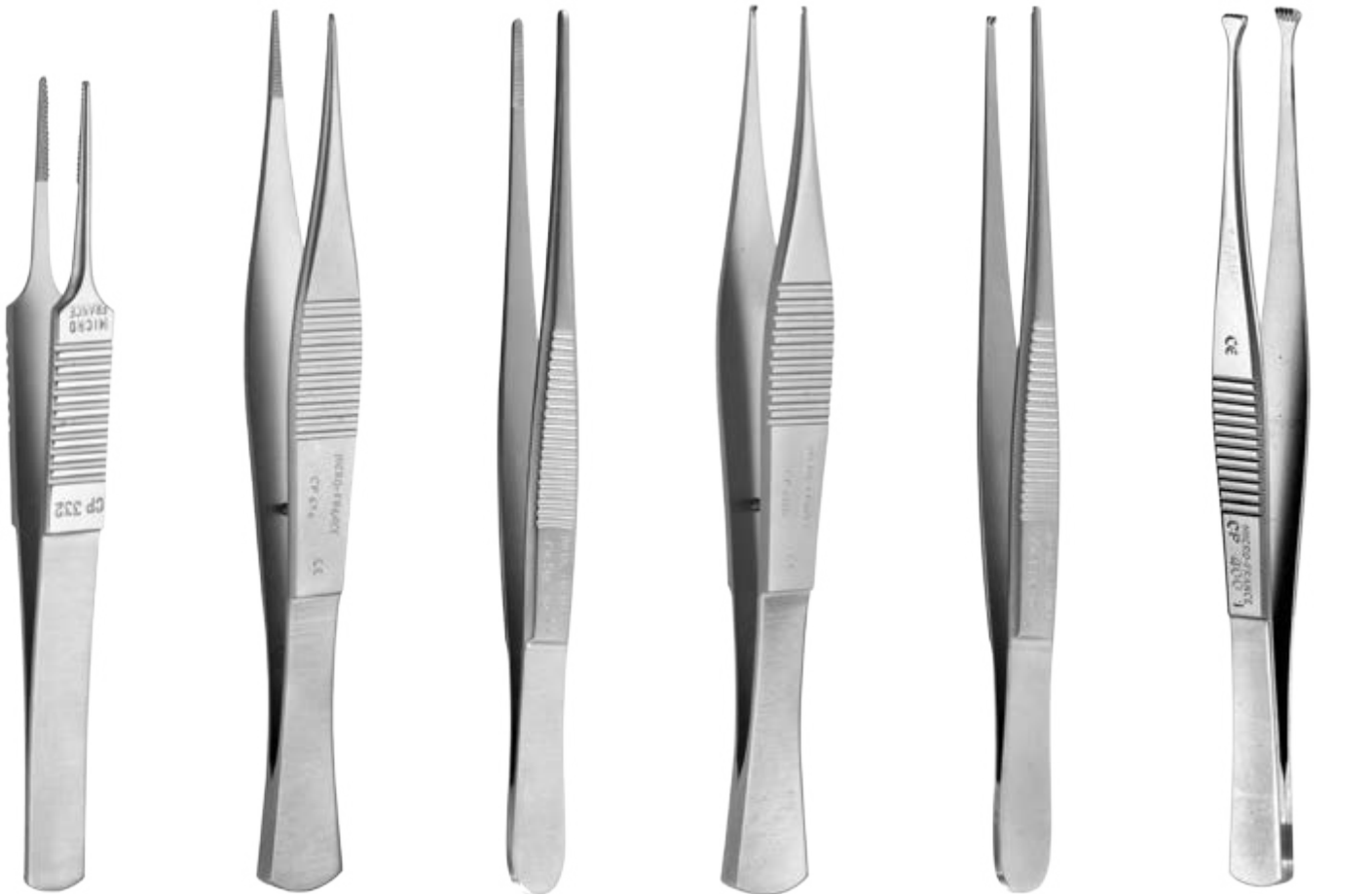

110mm
CP332

120mm
CP414
Jaws 1,0mm

120mm
7831A-12
Jaws 1,5mm

120mm
CP406
Jaws 1,0mm

120mm
7833A-12
Jaws 1,5mm

120mm
CP400-1
Jaws 5x5

150mm

Adson



CP604-15
Jaws 1,5mm
Serrated

Adson



CP605-15
Jaws 1,5mm
with teeth

Adson-Brown



CP606-15
Jaws 7x7

120mm



Adson-Tubiana

Adson

Adson-Brown

| M832 | M833 | CP604 | CP605 | 3740027 | CP606A | CP606 | 3740038 |
|------------|------------|------------|------------|---------------------|------------|----------|-------------|
| Jaws 1,0mm | Jaws 1,0mm | Jaws 1,5mm | Jaws 1,5mm | Jaws 1,0mm | Jaws 1,5mm | Jaws 7x7 | Jaws 7x7 |
| Serrated | with teeth | Serrated | with teeth | Serrated with teeth | Tungsten | | Angled jaws |

Mac-Indoe



140mm
CP934
Oblique teeth

Mac-Indoe

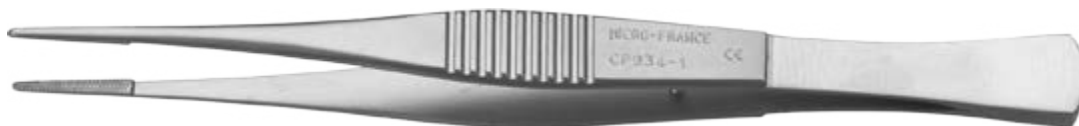

140mm
CP934-1
Serrated

Debaquey

Barraya

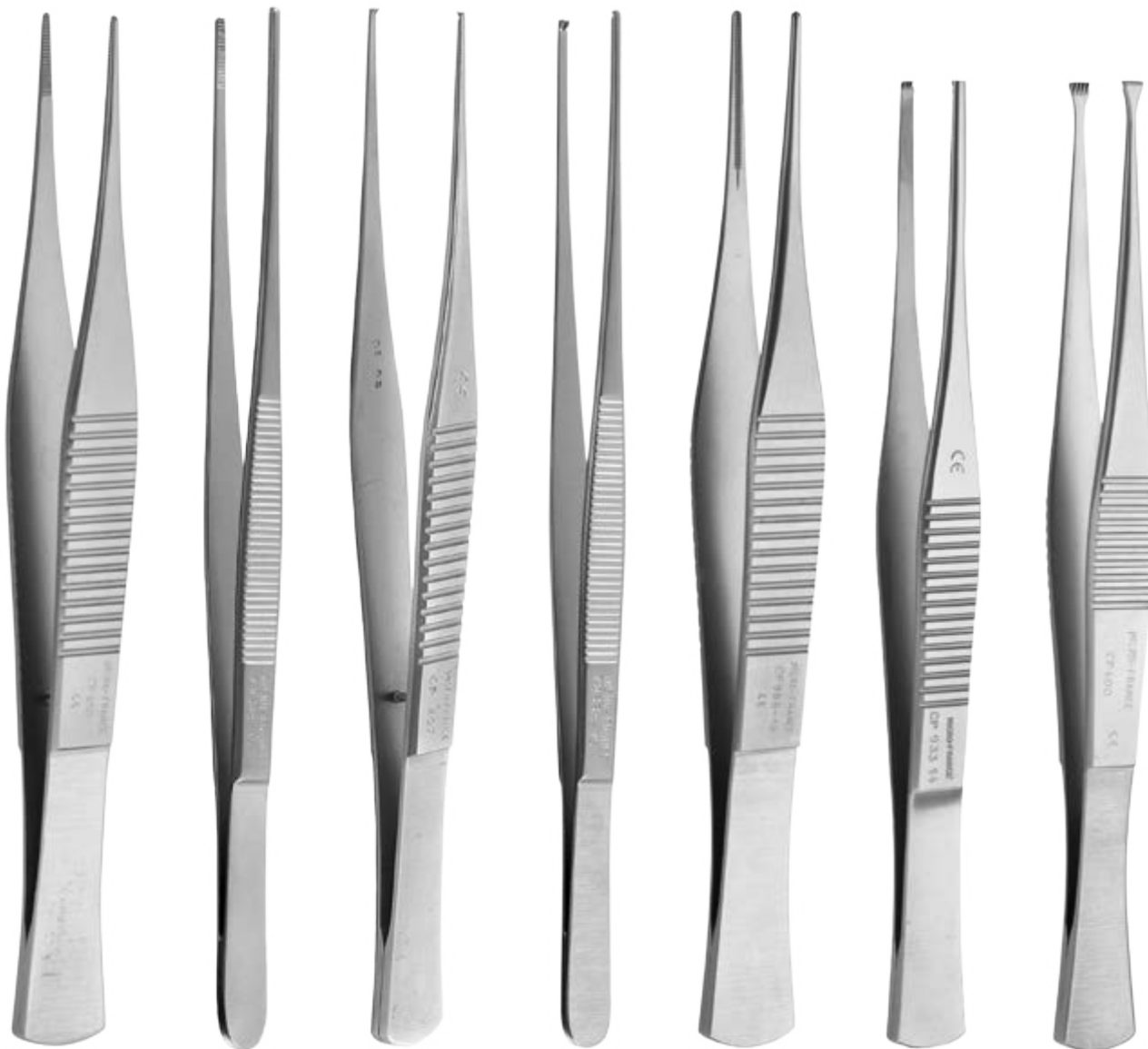

150mm

140mm

| | | | | | | |
|------------|------------|------------|------------|------------|----------|----------|
| CP415 | 7831A-15 | CP407 | 7833A-15 | CP988-15 | CP933-14 | CP400 |
| Jaws 1,0mm | Jaws 1,5mm | Jaws 1,0mm | Jaws 1,5mm | Jaws 1,5mm | Jaws 3x4 | Jaws 5x5 |

Cottle



110mm

3740067

14.0mm

Précelle



150mm

CP345

Barraya



160mm

CP933-16

3x4

Claoué



160mm

CP401

5x6

Mac-Indoe



170mm

CP936



150mm

3740015

2.0mm



150mm

3740019

2.0mm

Debaquey

Potts-Smith

Barraya



1.5mm

7831A-18



1.5mm

CP988-18



1.0mm

CP409

1x2



1.5mm

7833A-18

1x2



3.0mm

3740090

1x2



1.5mm

CP933-18

3x4



6x6

CP400-2

Gruenwald-Jansen

Debaquey



210mm

3711100



1.0mm

7832



2.0mm

7831A-20



1.5mm

CP988-20



2.0mm

7833A-20

1x2

Bipolar cables - 4,5 m



CP393-2

Bowa Emc Lamidey Valleylab



CP393-3

Erbe Storz Wolf



CP393-4

Aesculap Berchtold Martin

Magnan

Adson



110mm

CP392-1R

Jaws 1x8mm



120mm

CP604BR

serrated jaws



CP605BR

Jaws with teeth



160mm

CP392-2R

Jaws 1x8mm



CP392-8R

Jaws 1x8mm



200mm

CP392BI

Jaws 0,5x5mm



CP392BS

Jaws 0,5x5mm



CP392-3R

Straight
smooth jaws
1x8mm

CP392-10R

Angled
smooth jaws
1x8mm

CP392-5R

Bayonet
smooth jaws
1x8mm

CP392-5R

Bayonet
Angled jaws
1x8mm

Bipolar cables - 4,5 m



CP393-2
Bowa Emc Lamidey Valleylab



CP393-3
Erbe Storz Wolf



CP393-4
Aesculap Berchtold Martin

Scale 2/3

Dousset



Belghiti



Soubrane



Gayet



Partenski



| | | | | | |
|-----------|-----------|-----------|-----------|-------------|-------------|
| 300mm | 230mm | 230mm | 230mm | 240mm | 210mm |
| CEV392D30 | CEV392D20 | CEV392P20 | CEV392S20 | CEV392G24 | CEV392R15 |
| Jaws 3mm | Jaws 2mm | Jaws 2mm | Jaws 2mm | Jaws 5x15mm | Jaws 4x10mm |

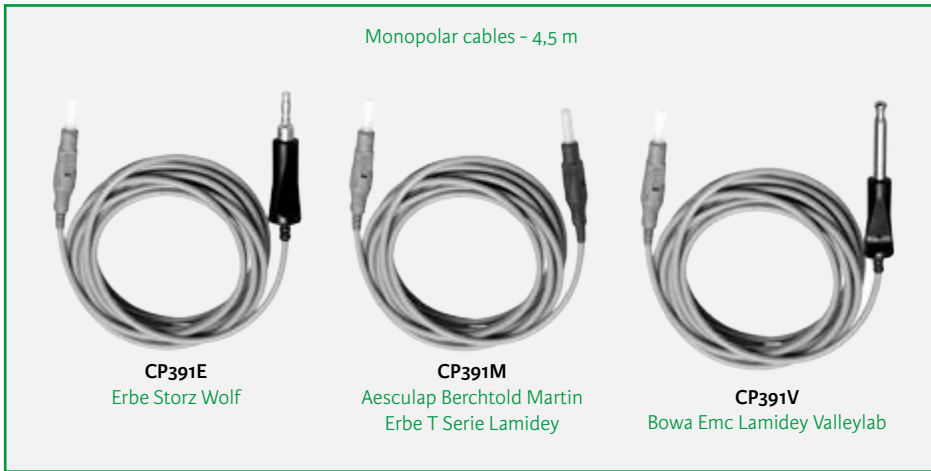

Adson



110mm

CP390-1

Jaws 1x8mm



120mm

CP604M

Serrated jaws



CP605M

Jaws with teeth



160mm

CP390-2

Jaws 1x8mm



CP390-8

Jaws with teeth

Scale 2/3

Working length «L»

Chambon



290mm L 260mm

CP390L26

smooth jaws 1x8mm



CP390-3

smooth jaws 1x8mm



230mm L 200mm

CP390-5

Angled jaws 1x8mm



CP390-7

smooth jaws 1x8mm

Monopolar cables 4.5 m



CP391E

Erbe Storz Wolf



CP391M

Aesculap Berchtold Martin
Erbe T Serie Lamidey



CP391V

Bowa Emc Lamidey Valleylab

Halsey

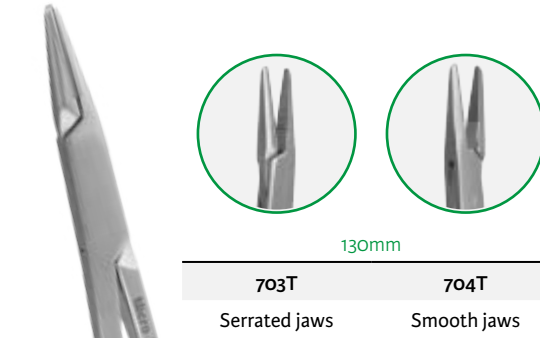

Ryder

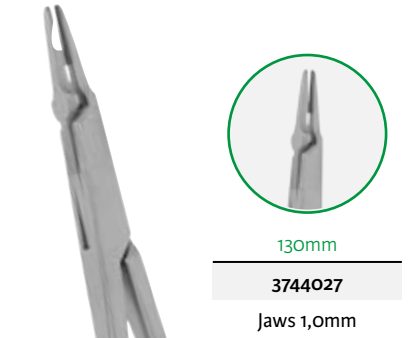

Crile-Wood



Becker

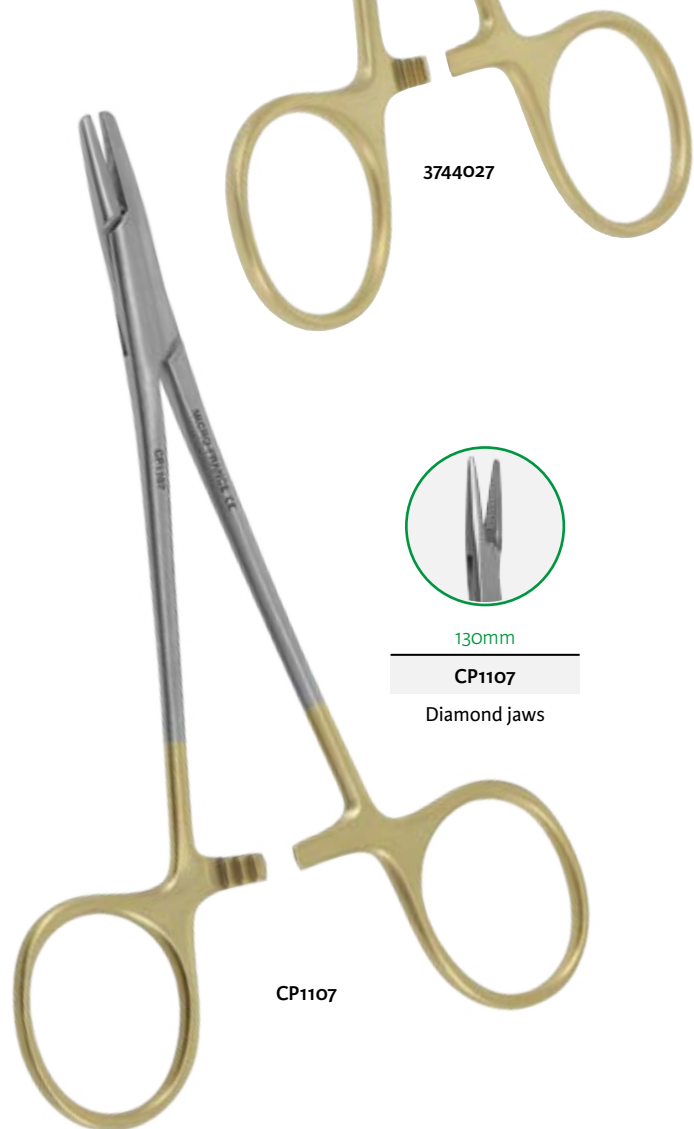

Crile-Wood

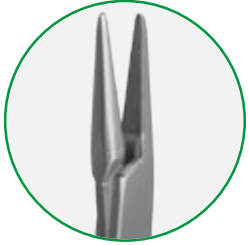

200mm

720T

Mayo-Hegar



200mm

3744032

Crile-Wood

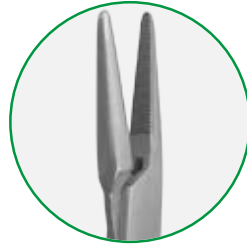

180mm

701T

Mayo-Hegar



180mm

3744031



720T



701T

Stratte

Needle-holder



210mm

7945T



7945T

Olsen-Webster

Needle-holder scissors

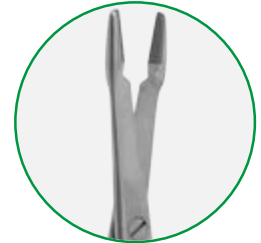

120mm

3744019



3744019

Hartmann-Mosquito

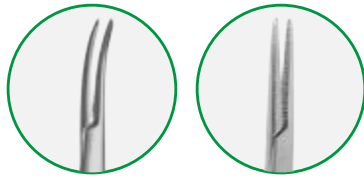

95mm

| | |
|----------------|----------------|
| 3755111 | 3755110 |
| Curved | Straight |
| Without teeth | |

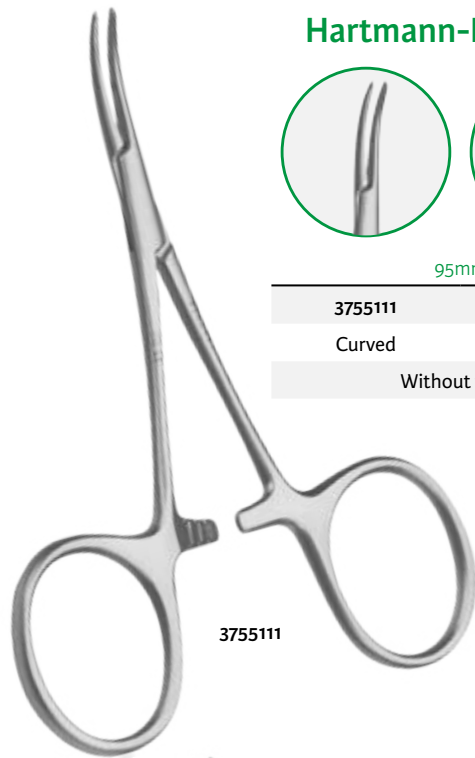

3755111

Halsted-Mosquito

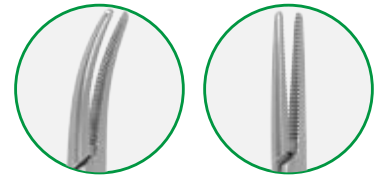

120mm

| | |
|----------------|----------------|
| 3755102 | 3755101 |
| Curved | Straight |
| Without teeth | |

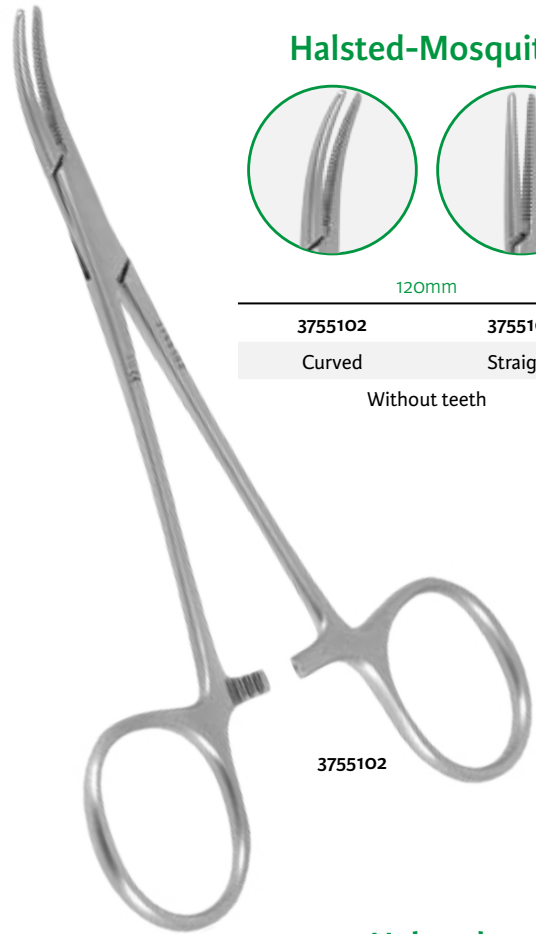

3755102

Leriche

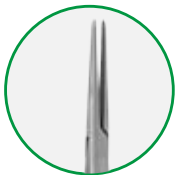

140mm

| |
|---------------|
| 7867-1 |
| Straight |
| Without teeth |

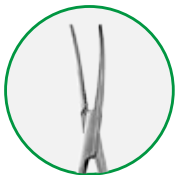

140mm

| |
|---------------|
| 7867-2 |
| Curved |
| Without teeth |

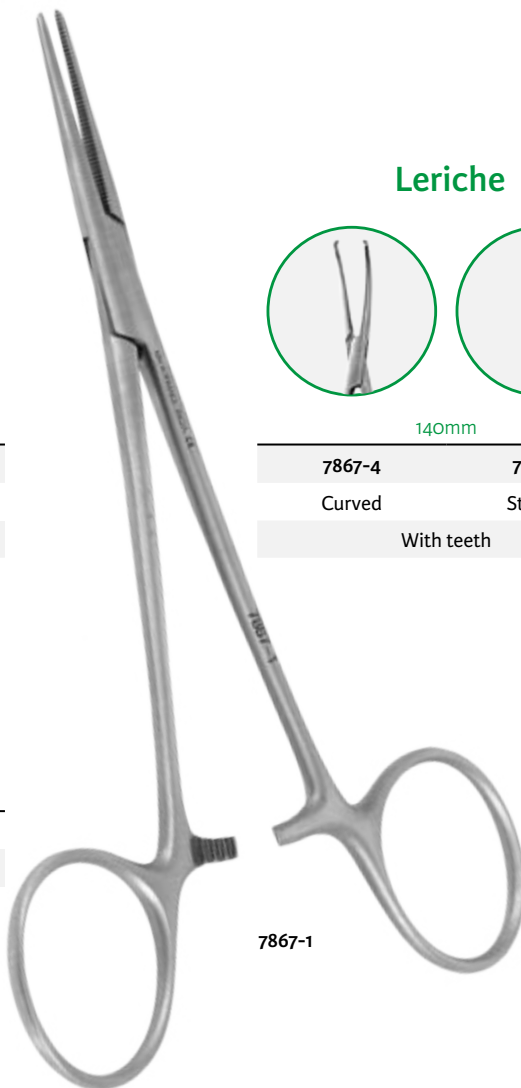

7867-1

Leriche

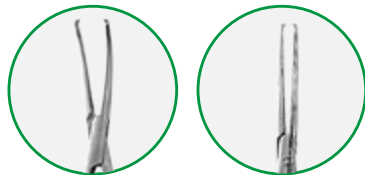

140mm

| | |
|---------------|---------------|
| 7867-4 | 7867-3 |
| Curved | Straight |
| With teeth | |

Halsted

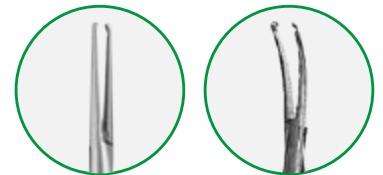

120mm

| | |
|---------------|---------------|
| P761-7 | P761-8 |
| Straight | Curved |
| With teeth | |

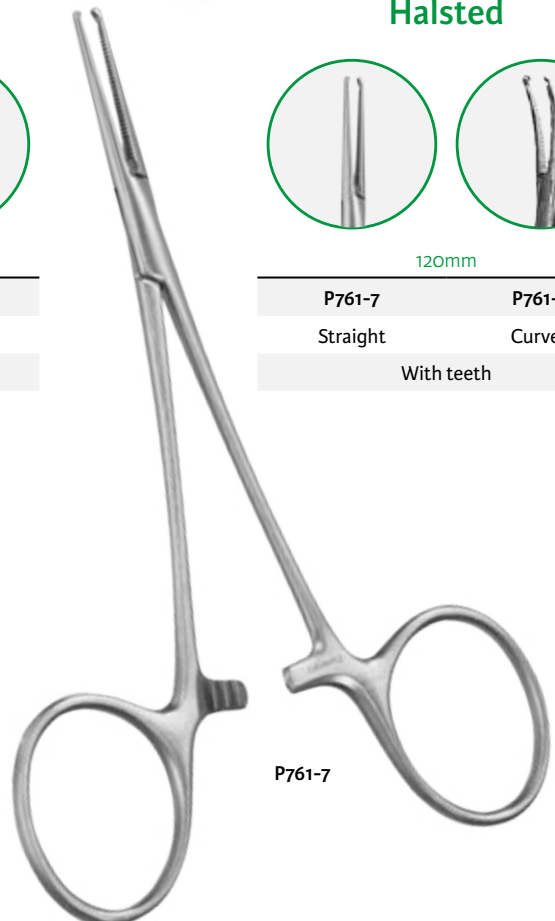

P761-7

Crile

140mm - Without teeth

Curved

Straight

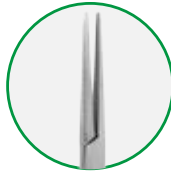

3755117

3755116

Kelly

140mm - Without teeth

Curved

Straight

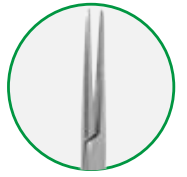
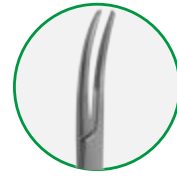

P762-2

3755114

160mm

P762-4

Rochester-Péan

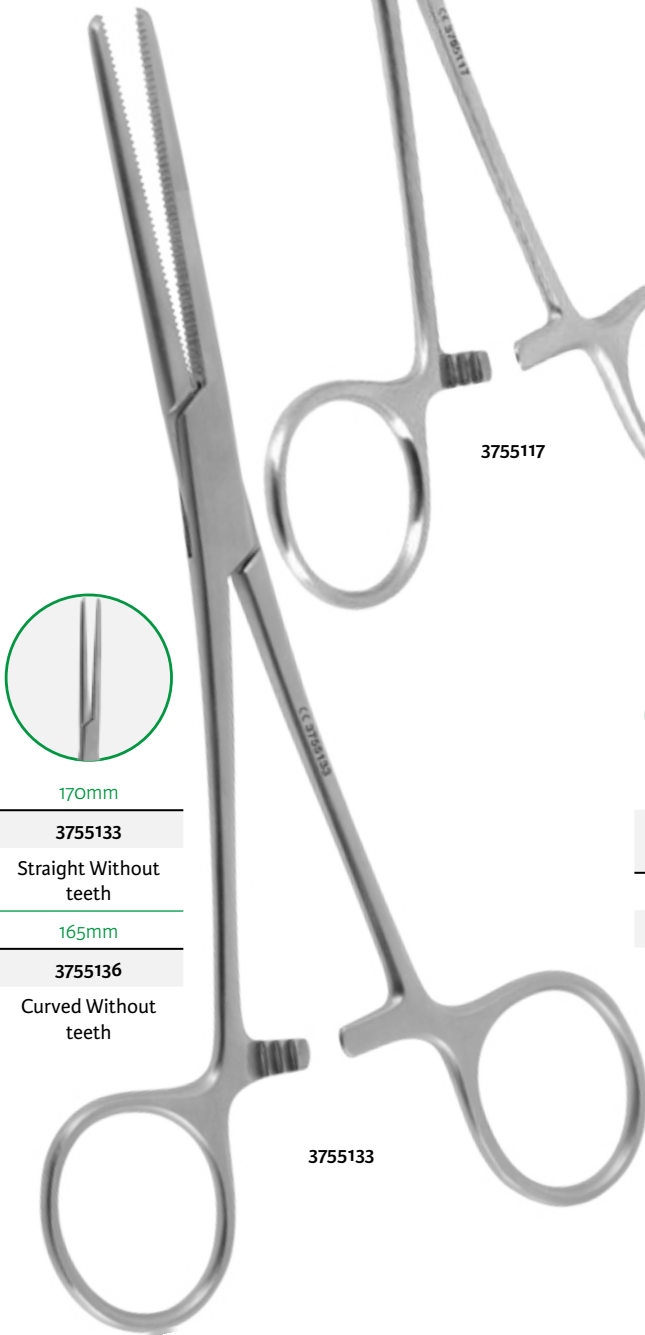

3755117

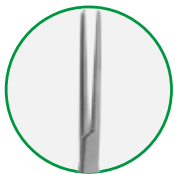

170mm

3755133

Straight Without teeth

165mm

3755136

Curved Without teeth

3755133

Kocher

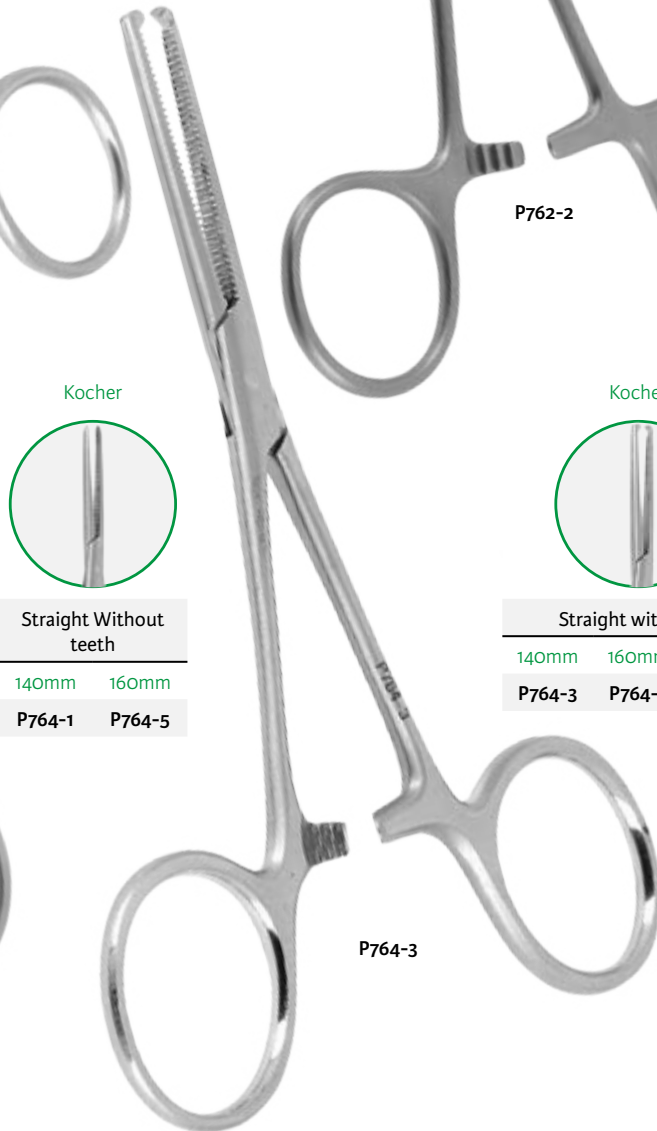

P762-2

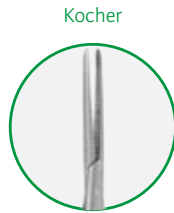

Kocher

Straight Without teeth

140mm

160mm

P764-1

P764-5

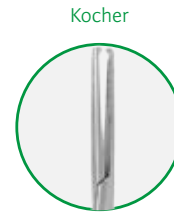

Kocher

Straight with teeth

140mm

160mm

180mm

P764-3

P764-7

P764-11

P764-3

Backauss

Towel clamp

90mm

3755000

120mm

3755001



3755000

Backauss-Roeder

Towel clamp



130mm

3755002

Martel

Forceps with teeth, «T» tip



130mm

P763



P763

Péan

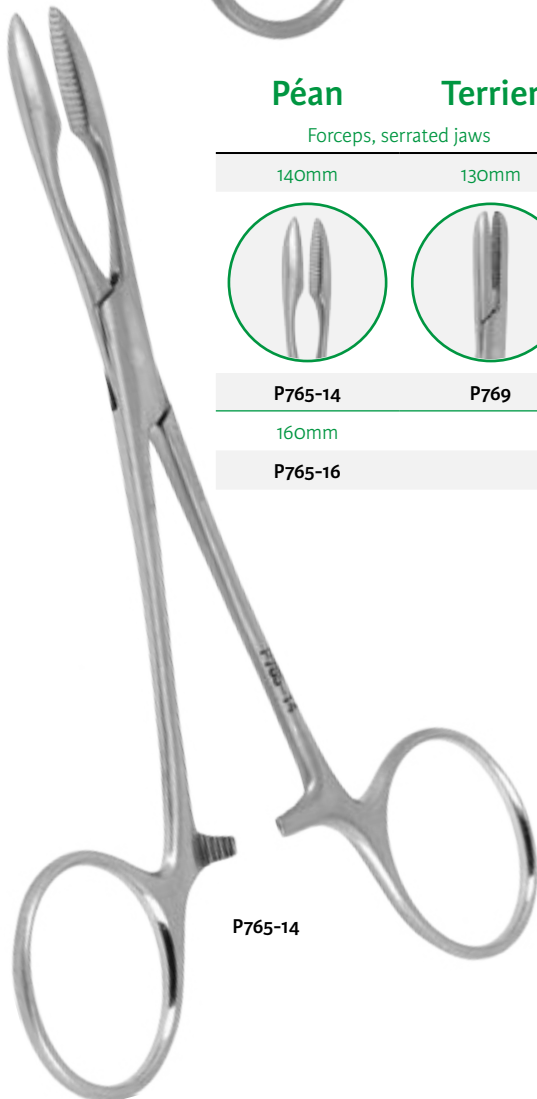

P765-14

Péan

Terrier

Forceps, serrated jaws

140mm

130mm

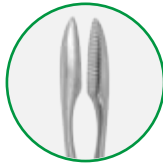

P765-14

160mm

P765-16

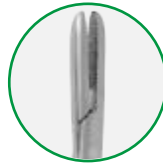

P769

Chaput



7866-13

Forceps, 2x3 teeth

130mm

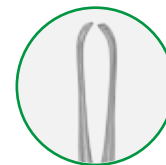

7866-13

Allis

Grasping forceps

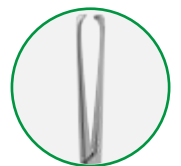

3755161

150mm
4x5 teeth

3755160

140mm
3x4 teeth

3755162

150mm
5x6 teeth

Babcock



Haemostatic forceps
heart serrated jaws

160mm

P770

Heart Jaws

Foerster

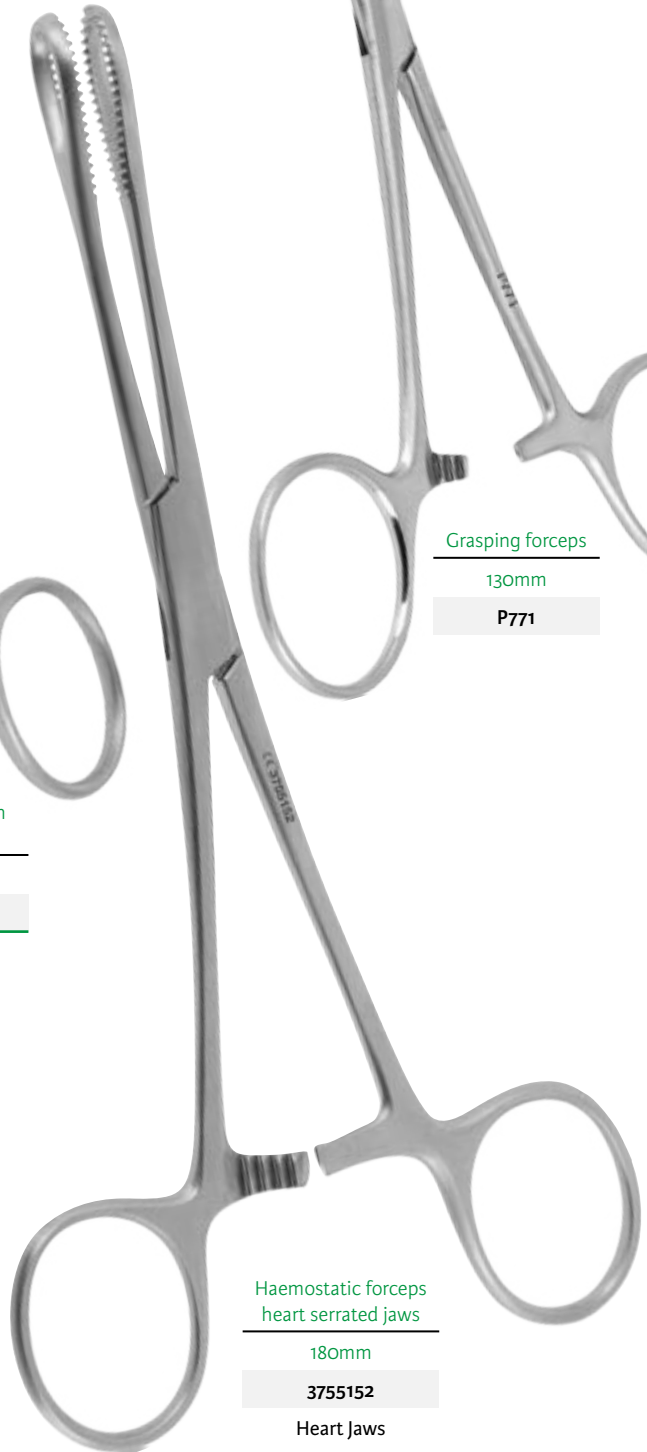

Haemostatic forceps
heart serrated jaws

180mm

3755152

Heart Jaws

Ombredanne



Grasping forceps

130mm

P771

Forceps with
teeth

160mm

3755100

Wertheimer

Jankowski

Lempert

- 1,5mm
- 2,0mm
- 2,5mm
- 3,0mm
- 3,5mm
- 4,0mm



Working length 120mm

| | |
|------------|-------|
| MCO770-3-5 | 3,5mm |
| MCO770-1-5 | 1,5mm |
| MCO770-2-0 | 2,0mm |
| MCO770-2-5 | 2,5mm |
| MCO770-3-0 | 3,0mm |
| MCO770-3-5 | 3,5mm |
| MCO770-4-0 | 4,0mm |



Working length 120mm

| | |
|------------|-------|
| MCEN770J40 | 4,0mm |
| MCEN770J30 | 3,0mm |



Working length 120mm

| | |
|------------|-------|
| MCO771-2-5 | 2,5mm |
| MCO771-3-0 | 3,0mm |
| MCO771-4-0 | 4,0mm |



Working length 110mm

| | |
|-----------|-------|
| CP330-3-0 | 3,0mm |
| CP330-4-0 | 4,0mm |

Scale 1/4

Suction tubes

Working length «L»

| | | 2,0mm | 2,5mm | 3,0mm | 3,5mm | 4,0mm | |
|-------|---------|-----------|-----------|-----------|-----------|-----------|-----------|
| 510mm | L 450mm | MCL920L45 | MCL925L45 | MCL930L45 | MCL935L45 | MCL940L45 | MCL940L45 |
| 610mm | L 550mm | MCL920L55 | MCL925L55 | MCL930L55 | MCL935L55 | MCL940L55 | |

Forceps

L 400mm

| Forceps | Crocodile jaws | Curette jaws Ø 4,0mm | Curette jaws up opening 3,5x10mm | Curette jaws upward Ø 4,0mm | |
|---------------|----------------|-------------------------|-------------------------------------|--------------------------------|-----------|
| 480mm L 400mm | 7844T3L40 | 7844T5L40 | 7844T6L40 | 7844T74L40 | 7844T5L40 |
| 530mm L 450mm | 7844T3L45 | 7844T5L45 | 7844T6L45 | 7844T74L45 | |
| 580mm L 500mm | 7844T3L50 | 7844T5L50 | 7844T6L50 | 7844T74L50 | |
| 630mm L 550mm | 7844T3L55 | 7844T5L55 | 7844T6L55 | 7844T74L55 | |
| 680mm L 600mm | 7844T3L60 | 7844T5L60 | 7844T6L60 | 7844T74L60 | |

Esophagoscope

MCL320
330mm 12x16mm

L 300mm

Handle
MCL112H
150mm

Fiber
MCL320F
290mm - Ø3,0mm

MCL330
530mm 12x16mm

L 500mm

Handle
MCL112H
150mm

Fiber
MCL330F
490mm - Ø3,0mm

Container
7874MF-61
640x189x95mm - L 610x180x80mm

Scale 1/3

Scale 1/4

Working length «L»



| | | 2,0mm | 2,5mm | 3,0mm | 3,5mm | 4,0mm | |
|-------|---------|-----------|-----------|-----------|-----------|-----------|-----------|
| 310mm | L 250mm | MCL920L25 | MCL925L25 | MCL930L25 | MCL935L25 | MCL940L25 | MCL930L25 |
| 410mm | L 350mm | MCL920L35 | MCL925L35 | MCL930L35 | MCL935L35 | MCL940L35 | |

Suction tubes

Forceps

| | | Forceps | Crocodile jaws | Curette jaws Ø 4,0mm | Curette jaws up opening 3,5x10mm | Curette jaws upward Ø 4,0mm | |
|-------|---------|-----------|----------------|-------------------------|-------------------------------------|--------------------------------|--|
| 280mm | L 400mm | 7844T3L20 | 7844T5L20 | 7844T6L20 | 7844T74L20 | 7844T5L25 | |
| 330mm | L 450mm | 7844T3L25 | 7844T5L25 | 7844T6L25 | 7844T74L25 | | |
| 380mm | L 500mm | 7844T3L30 | 7844T5L30 | 7844T6L30 | 7844T74L30 | | |
| 430mm | L 550mm | 7844T3L35 | 7844T5L35 | 7844T6L35 | 7844T74L35 | | |

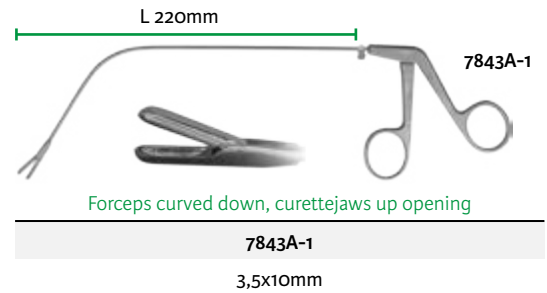
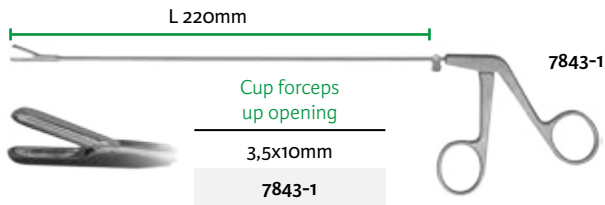

Jackson

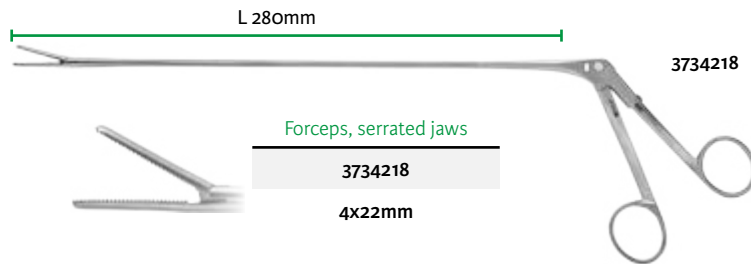

Hypopharyngoscope

| | | | | |
|---------|----------------|---------|--|--|
| MCL110 | 200mm | 9x14mm | | |
| MCL111 | 195mm - Ø3,0mm | | | |
| MCL112 | 230mm | 12x16mm | | |
| MCL112H | 150mm | | | |
| MCL112F | 195mm - Ø3,0mm | | | |

Scale 1/3

Working length «L»

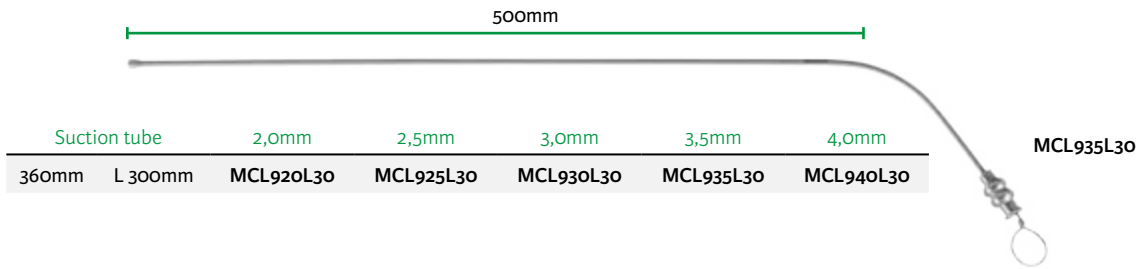

Lacau

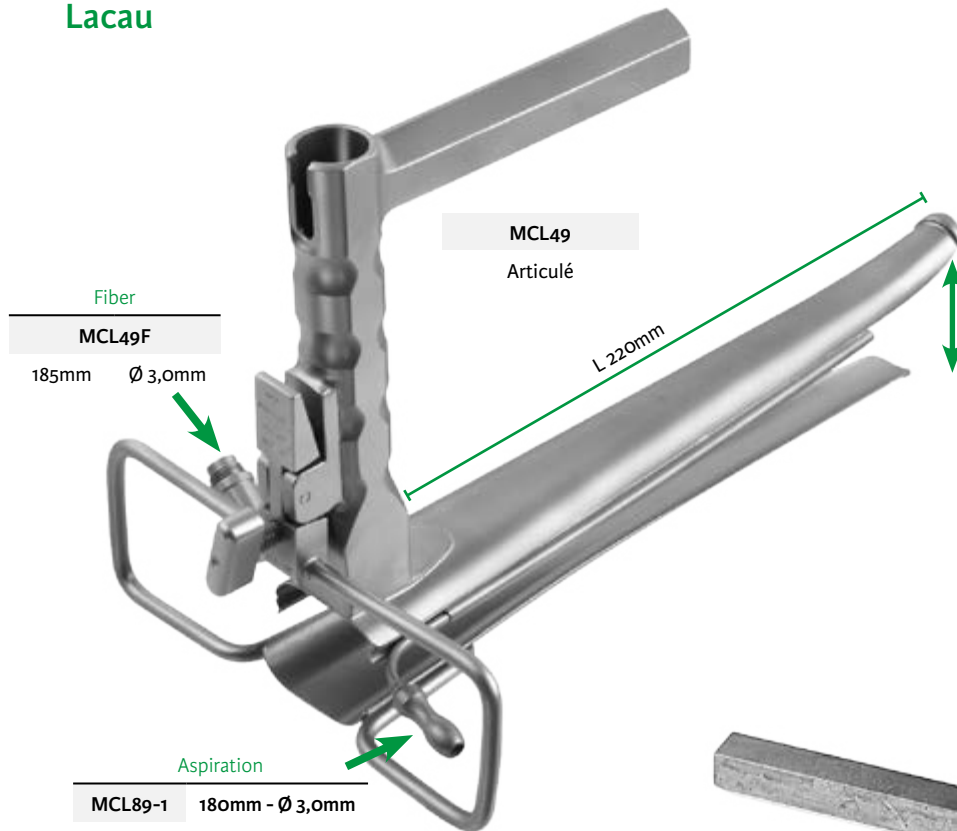

Reyt

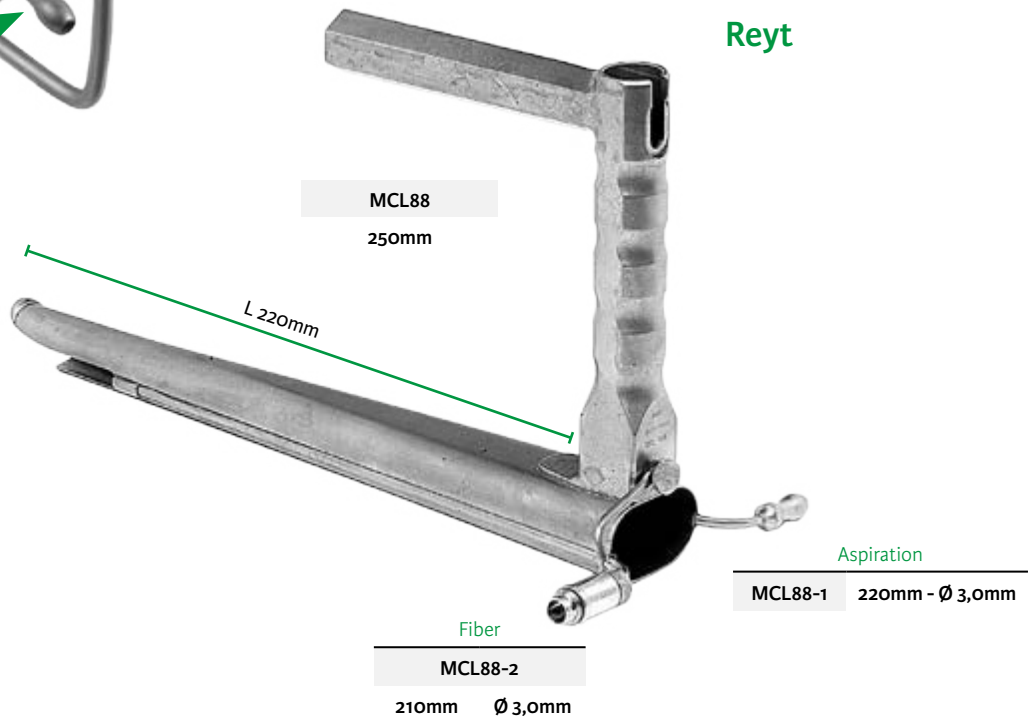

Photos for illustration purposes, unscaled

Bouchayer



Laryngoscope arm holder

MCL76

Bouchayer

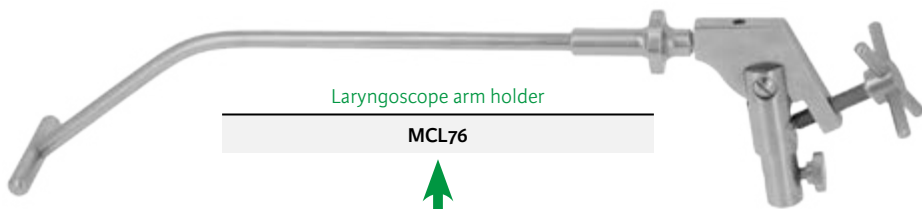

MCL35 + MCL76

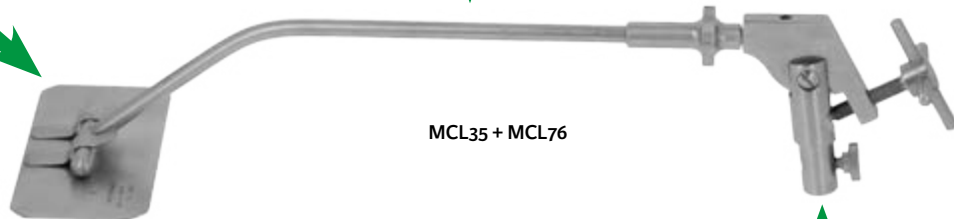

Mustard

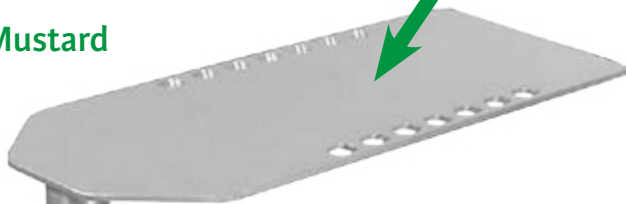

Table

3734500

225x595mm

Operating table clamp

CEV984

Cold light

Adapters

Storz

MCL75

Wolf

MCL171^{(D)(f)}

Storz

MCL174^{(D)(f)}

Cold light cable

MCL38N^(D)

2200mm

Wolf

MCL170^{(D)(f)}

Storz

MCL173^{(D)(f)}

Olympus

MCL197^{(D)(f)}

^(f) Not a MEDICAL DEVICE

^(D) Distributed by Integra MicroFrance SAS (France)

Scale 1/3

Working length «L»

Lescanne

75mm
MCL37D
Opening 8x10mm

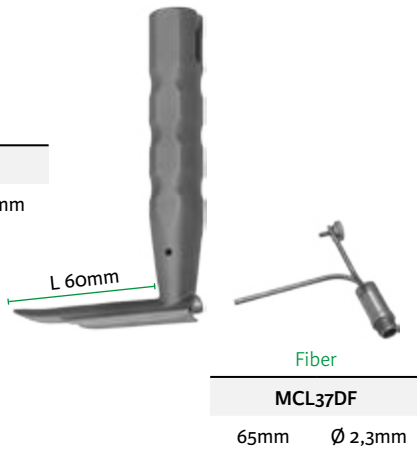

Lescanne

70mm
MCL37C
Opening 13x15mm

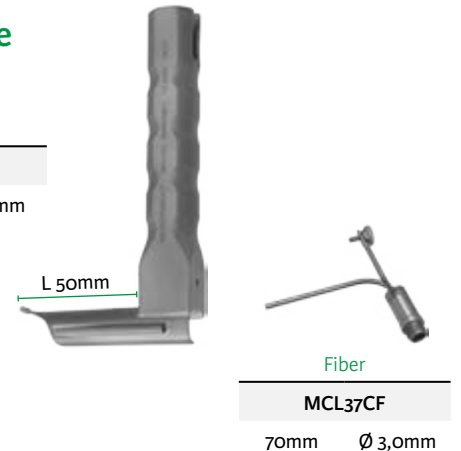

Garabédian

100mm
MCL37G
Opening 13x15mm

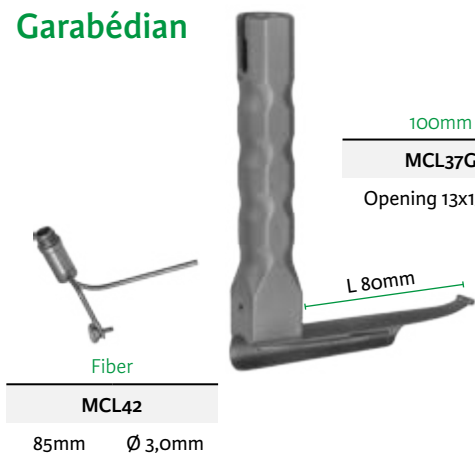

Garcin

100mm
MCL37
14x15mm
Opening 13x12mm

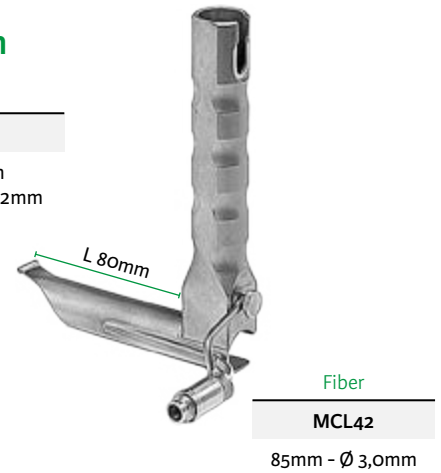

Legent

170mm
MCL52
18x15mm
Opening 17x14mm

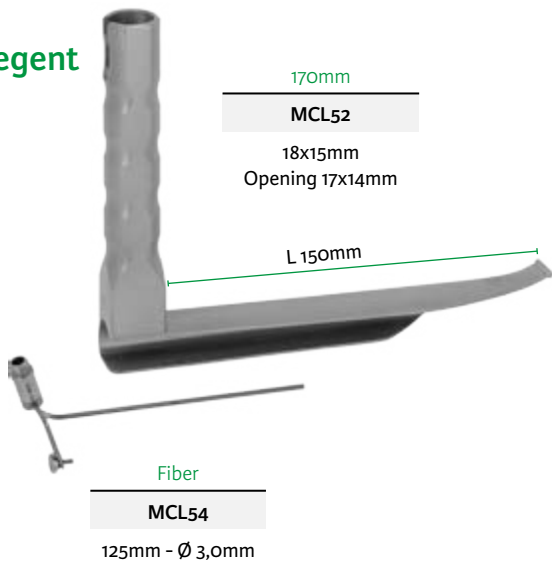

Legent

150mm
MCL51
18x15mm
Opening 17x12mm

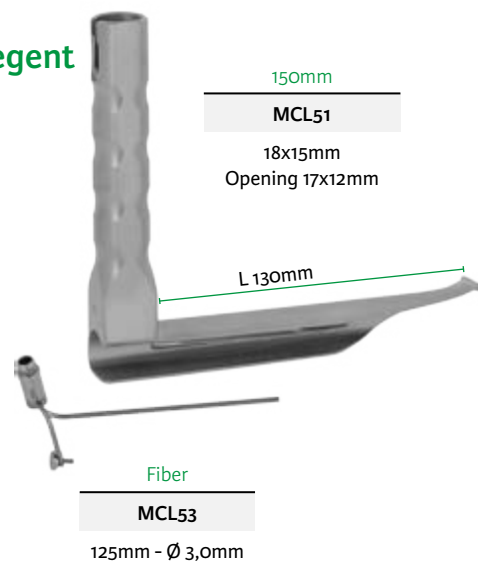

Scale 1/3

Working length «L»

Bouchayer

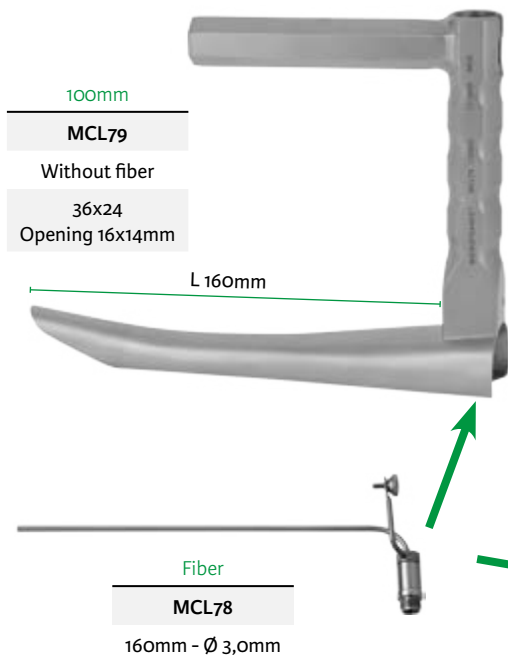

Bouchayer

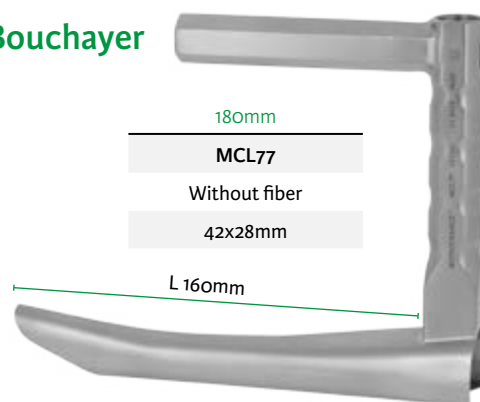

Pignat

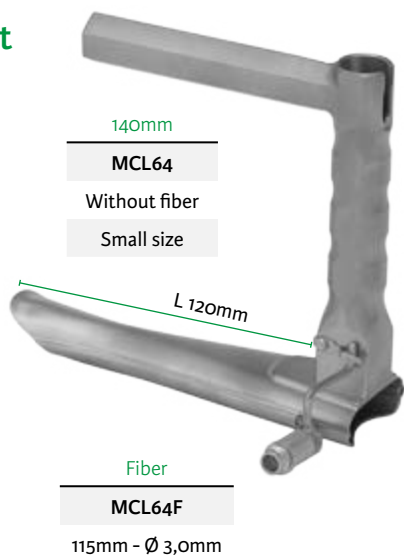

Pignat

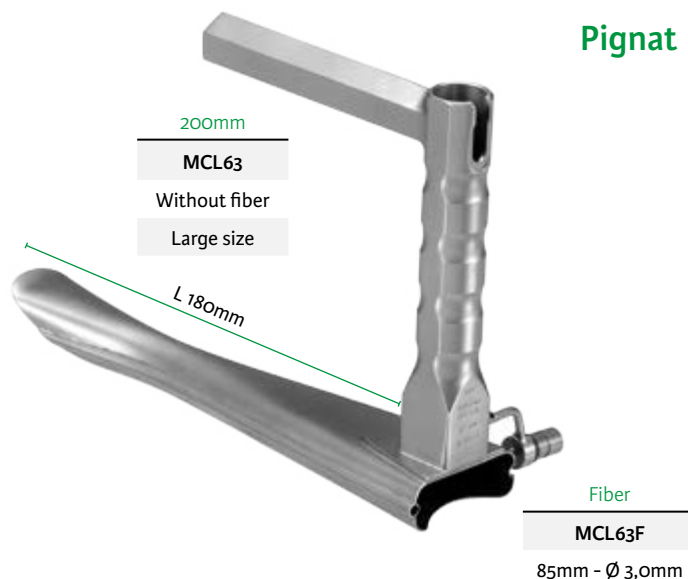

Scale 1/3

Working length «L»

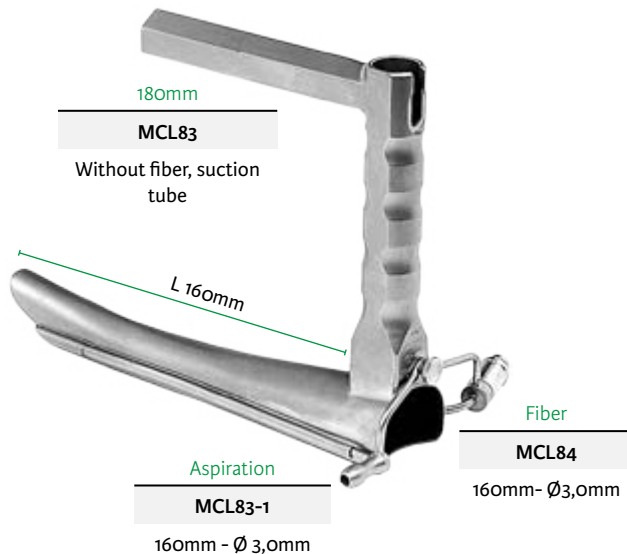
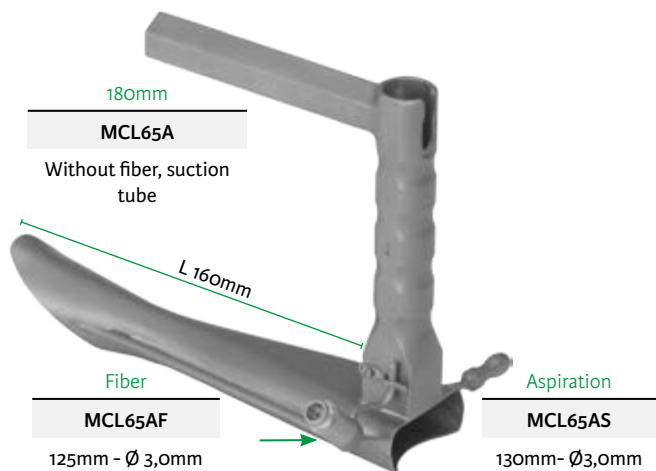

Abitbol

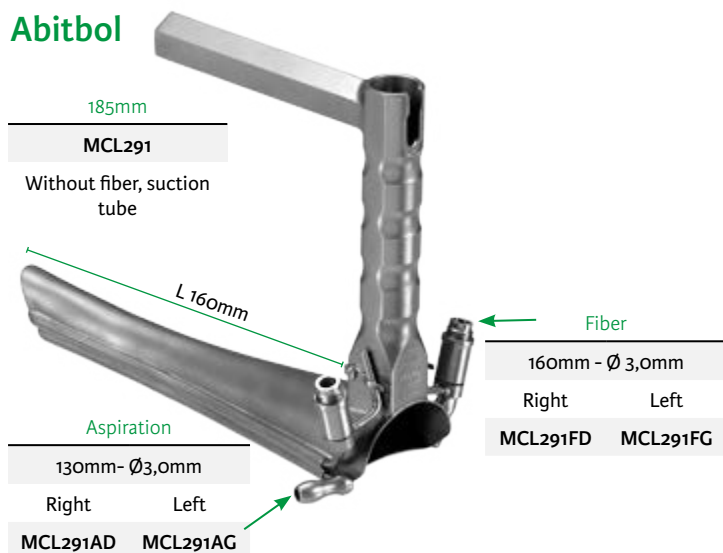

Brasnu

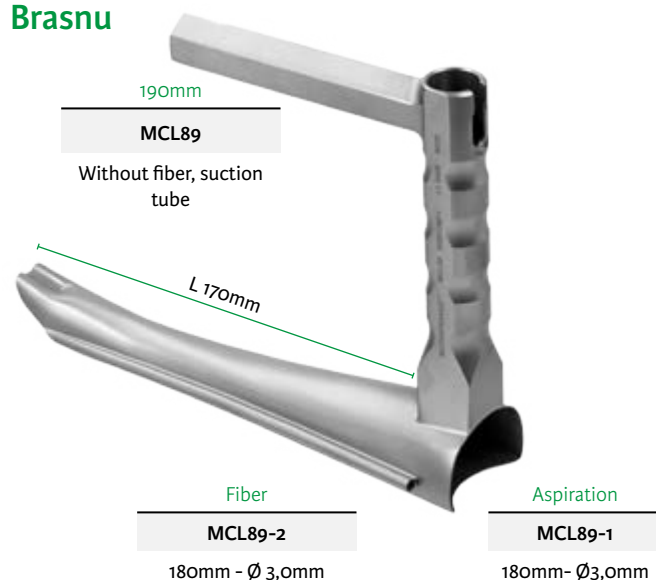

Abitbol

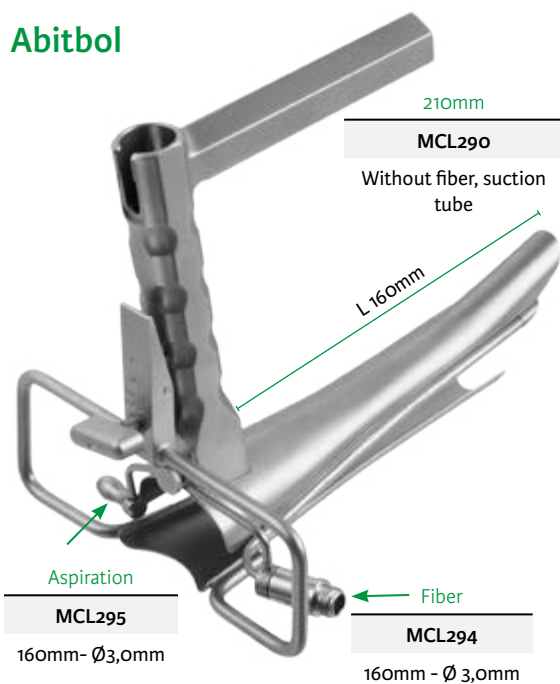

Dédo-Frèche

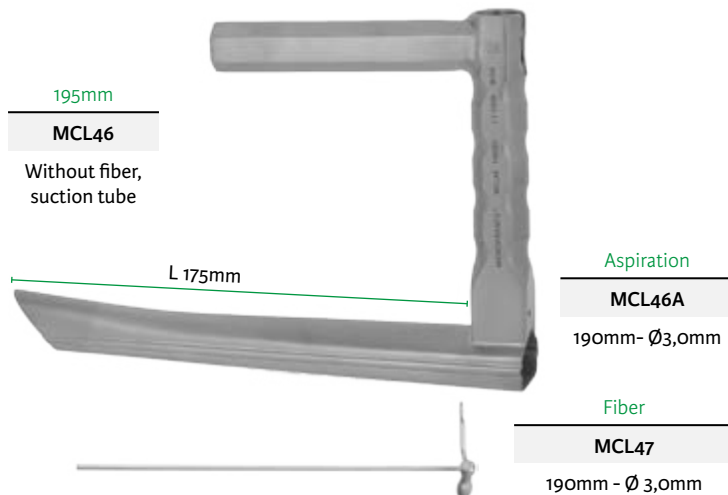

Scale 1/3

Sataloff

Working length «L»

180mm
MCL120
With fiber and suction tube
16x20mm
Opening 8x9mm

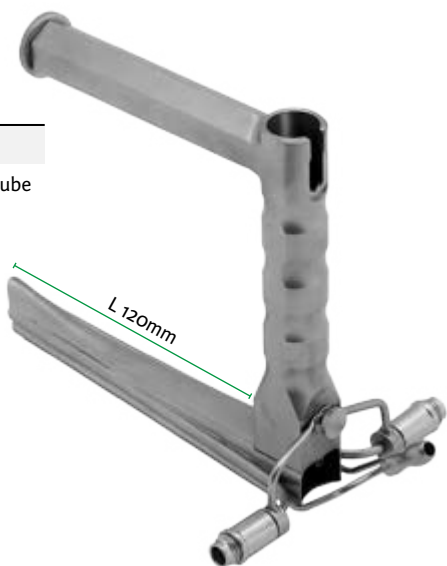

210mm
MCL121
With fiber and suction tube
19x16mm
Opening 12x14mm

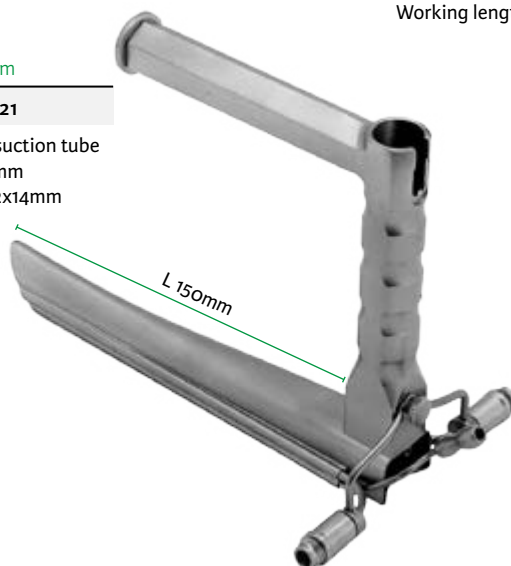

210mm
MCL122
With fiber and suction tube
21x30mm
Opening 12x16mm

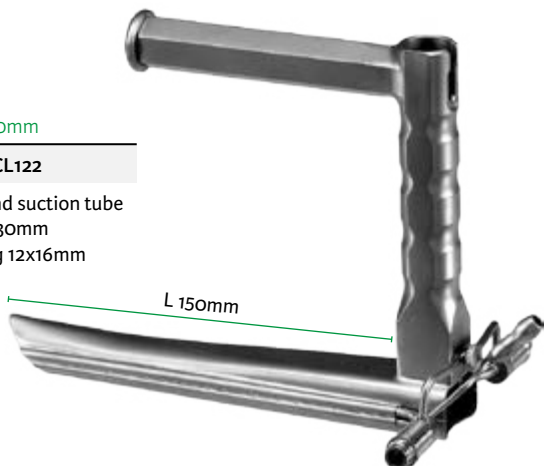

175mm
MCL123
With fiber and suction tube
15x27mm
Opening 13x16mm

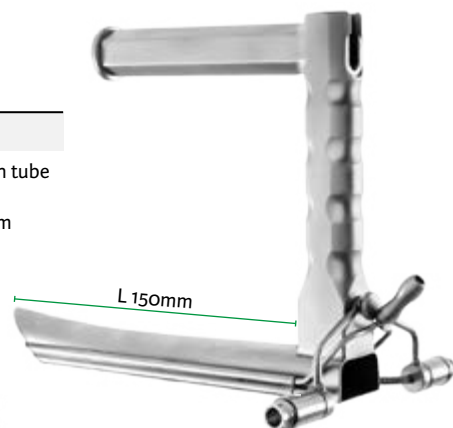

175mm
MCL124
With fiber and suction tube
25x35mm
Opening 14x15mm

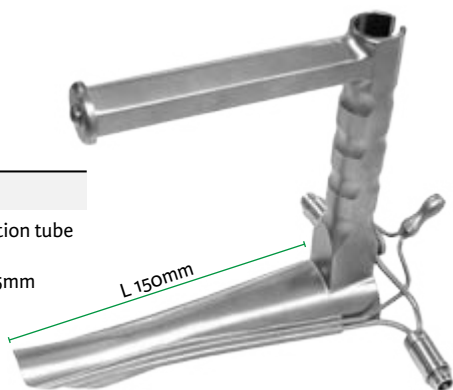

170mm
MCL125
With fiber and suction tube
17x26mm
Opening 10x14mm

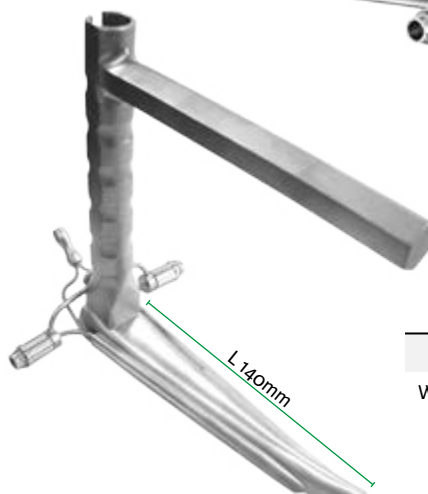

| Complete laryngoscope | Right cold lighth fiber | Left cold lighth fiber | Dual suction tube |
|-----------------------|-------------------------|------------------------|-------------------|
| MCL120 | MCLS120-2 | MCLS120-1 | MCLS120-3 |
| MCL121 | MCLS121-2 | MCLS121-1 | MCLS121-3 |
| MCL122 | MCLS122-2 | MCLS122-1 | MCLS122-3 |
| MCL123 | MCLS123-2 | MCLS123-1 | MCLS1233 |
| MCL124 | MCL124FR | MCL124FL | MCL124ST |
| MCL125 | MCL125FR | MCL125FL | MCL124ST |

Suction tube

Bouchayer



MCL10
300mm
Ø 2,5mm

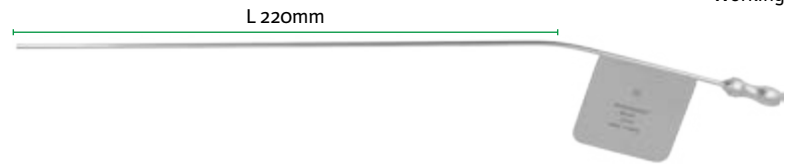

Working length «L»

Scale 1/3

Blunt eyes suction tube

Brasnu

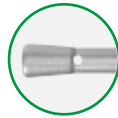

MCL100
300mm
Ø 2,5mm

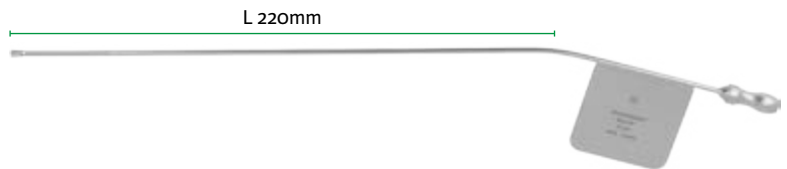

Garabédian



MCL100T20 MCL100T15
300mm
Ø 2,0mm Ø 1,5mm

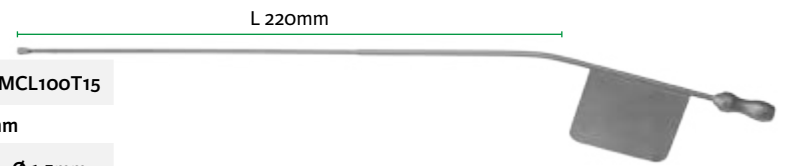

Insulated suction tube with finger control

Abitbol



MCL210
300mm - Ø
2,5mm

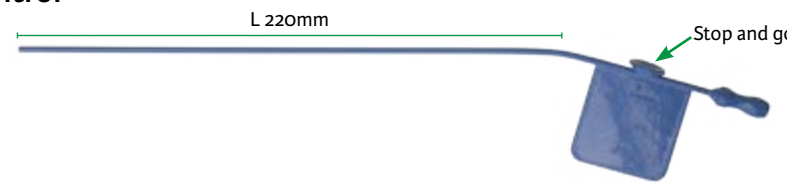

Suction tube with finger control



3734111 3734109 3734110
Ø 3,0mm Ø 2,0mm Ø 2,5mm

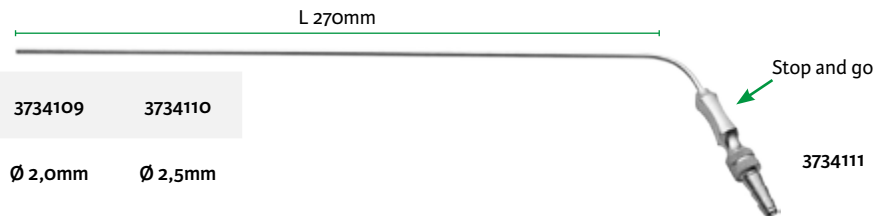

Dual suction tube

Huttenbrink

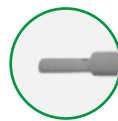

MCL103
285mm
Ø 2,5mm

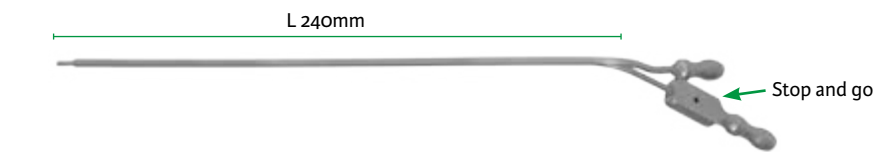

Sataloff suction tube

Sataloff

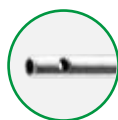

Velvet eye suction tube
MCL-S16



Suction tube down
MCL-S17



Suction tube up
MCL-S17-1

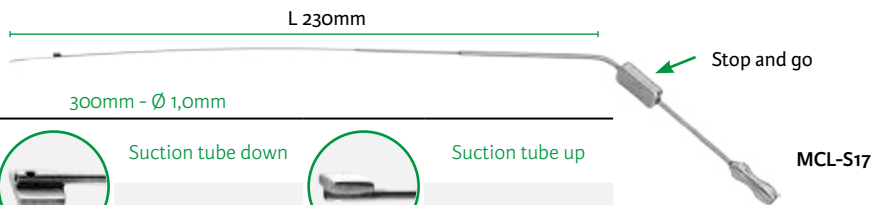

MCL-S17

Working length «L»

Scale 1/3



| | | |
|-------|-------|----------|
| MCL18 | MCL15 | MCL25 |
| Right | Left | Straight |

Forceps, serrated jaws - 300mm

L 220mm

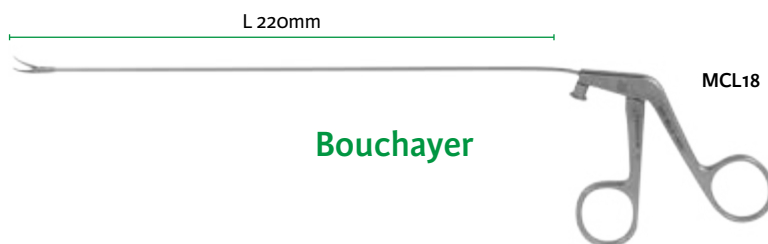

Bouchayer

MCL18



| | |
|-------|----------|
| MCL19 | MCL19BIS |
| Left | Right |

Heart-shaped forceps 45° - 300mm

L 220mm

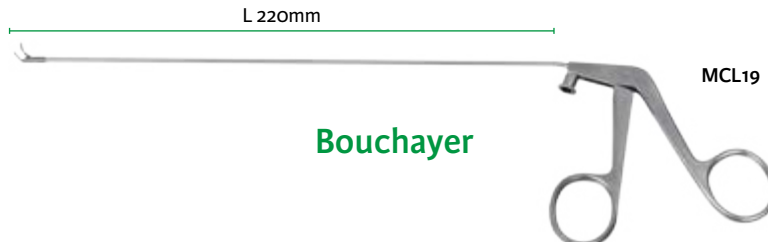

Bouchayer

MCL19

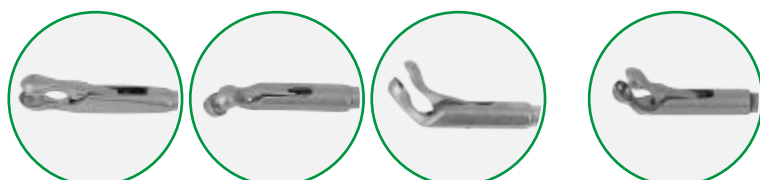

| | | | |
|-------|-------|-------|--------|
| MCL12 | MCL29 | MCL30 | MCL33 |
| | Left | Right | Upward |
| | 45° | 45° | |

Cup forceps Ø 2,0mm - 300mm

L 220mm

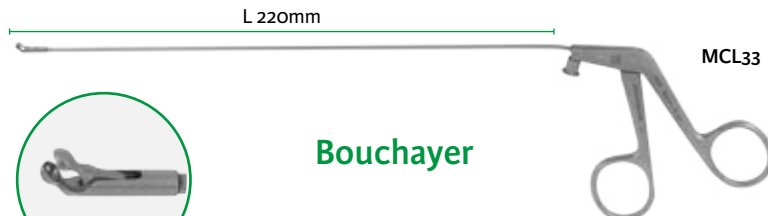

Bouchayer

MCL33



| | | |
|--------|-------|-------|
| MCL67 | MCL68 | MCL69 |
| Upward | Left | Right |

Cup forceps, oval jaws - 300mm

L 220mm

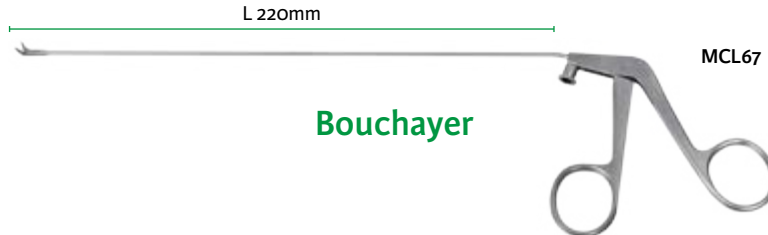

Bouchayer

MCL67

Working length «L»

Scale 1/3

Knives

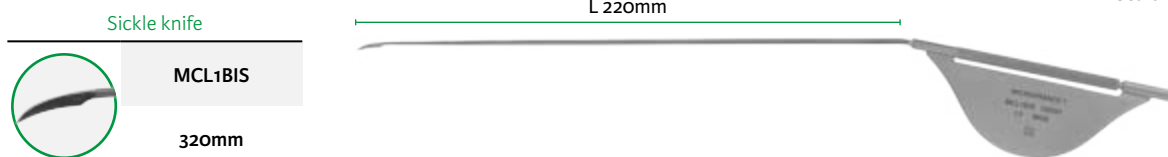

Bouchayer



Bouchayer



Pérouse

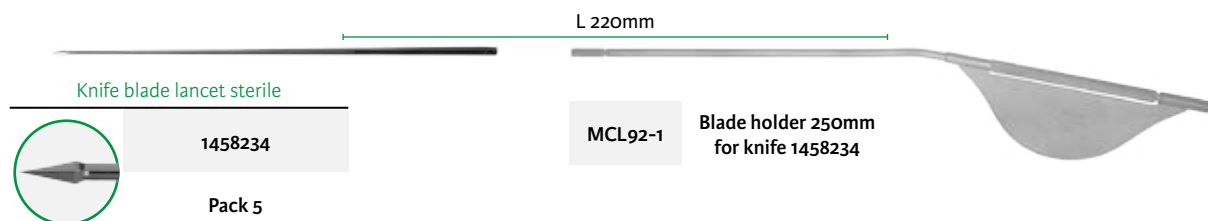

Garabédian



Micro scissors

Bouchayer

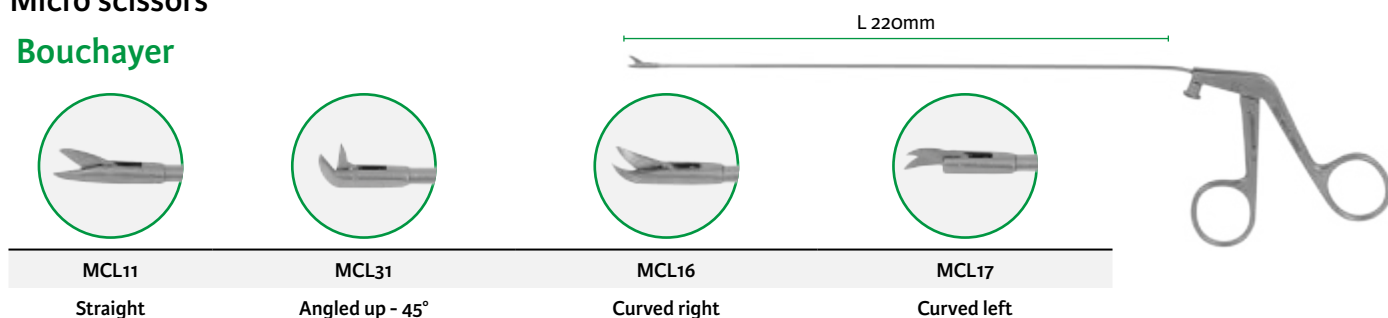

Woo



^(D) Distributed by Integra MicroFrance SAS (France)

Scale 1/3

Working length «L»

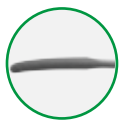

MCL56BL
Curved left



Bouchayer

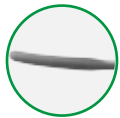

MCL56BR
Curved right

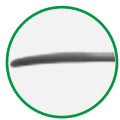

MCL56PL
Curved left

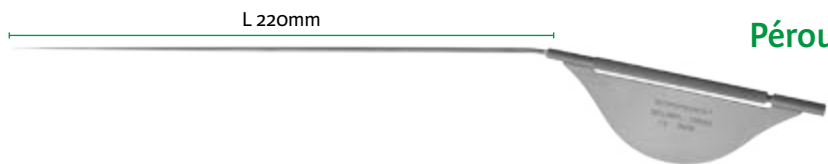

Pérouse

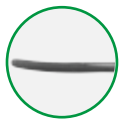

MCL56PR
Curved right



MCL81BL
Curved left
90°



Bouchayer



MCL81BR
Curved right
90°

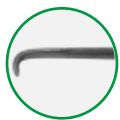

MCL81PL
Curved left
90°

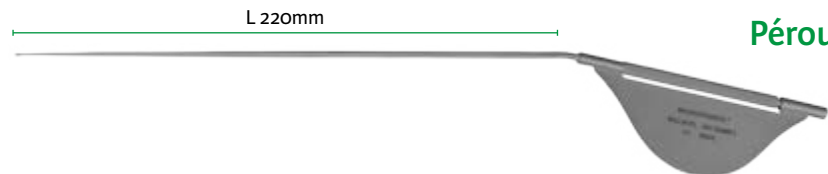

Pérouse

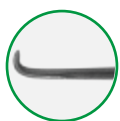

MCL81PR
Curved right
90°



Abitbol

Working length «L»

Scale 1/3

Insulated suction tube with finger control



MCL210
300mm - Ø 2,5mm

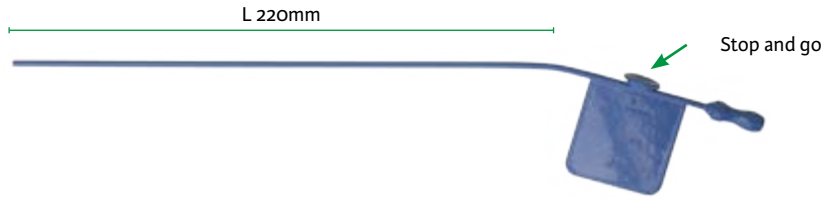

Monopolar fenestrated forceps with suction



MCL205
320mm



Heart-shaped forceps, monopolar with suction



MCL219
320mm
Curved right



MCL219-1
320mm
Curved left

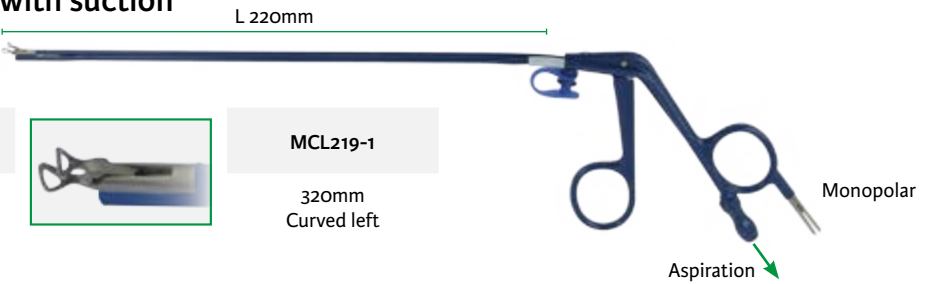

Alligator forceps, monopolar with suction



MCL241
320mm
Curved right



MCL241-1
320mm
Curved left

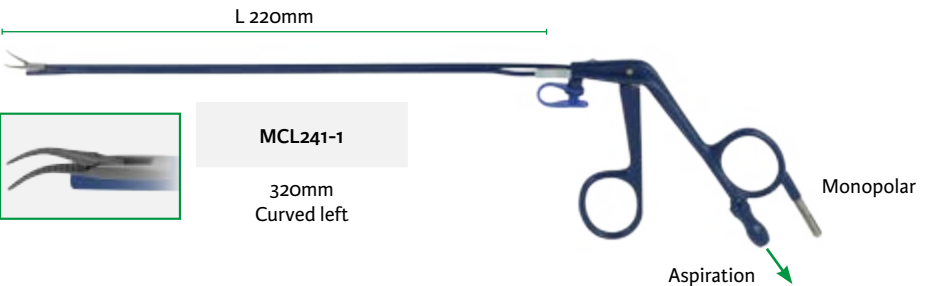

| Monopolar cables - 4,5 m | | |
|--------------------------|--|----------------------------|
| | | |
| CP391E | CP391M | CP391V |
| Erbe Storz Wolf | Aesculap Berchtold Martin Erbe T Serie Lamidey | Bowa Emc Lamidey Valleylab |

Working length «L»

Scale 1/3

Sataloff

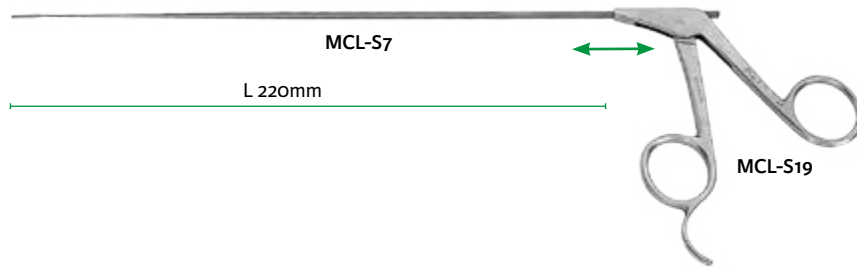

Assembly of Sataloff instruments

Dismantled instruments



Angled handle

MCL-S19

pack 2

MCL-S19

Knife blades



MCL-S6

pack 6

MCL-S9

Sharp
right angled

Ball dissectors



MCL-S11

45°
Ø 3,0mm

MCL-S12

90°
Ø 2,5mm

MCL-S13

90°
Ø 3,0mm

Micro Spatula



MCL-S8

Angled
20°

MCL-S1

Curved
1x9mm

MCL-S7

Straight
1x10mm

Other dismantled instruments

Retractor

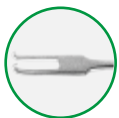

MCL-S2

Sharp, 2 prongs

Mirror



MCL-S14

70° - Ø 3,5mm



MCL-S15

70° - Ø 5,0mm

Ball dissector

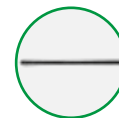

MCL-S10

for palpation

Cotton carrier

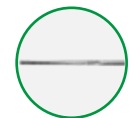

MCL-S3

Curved curette for cyst

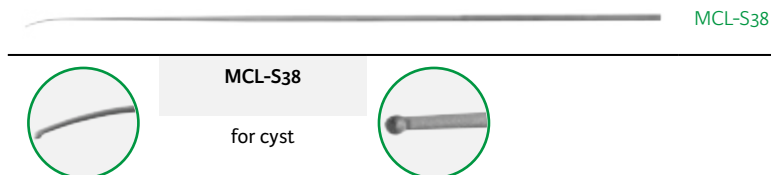

MCL-S38

for cyst

MCL-S38

Forceps

Scale 2/3

Working length «L»

Sataloff

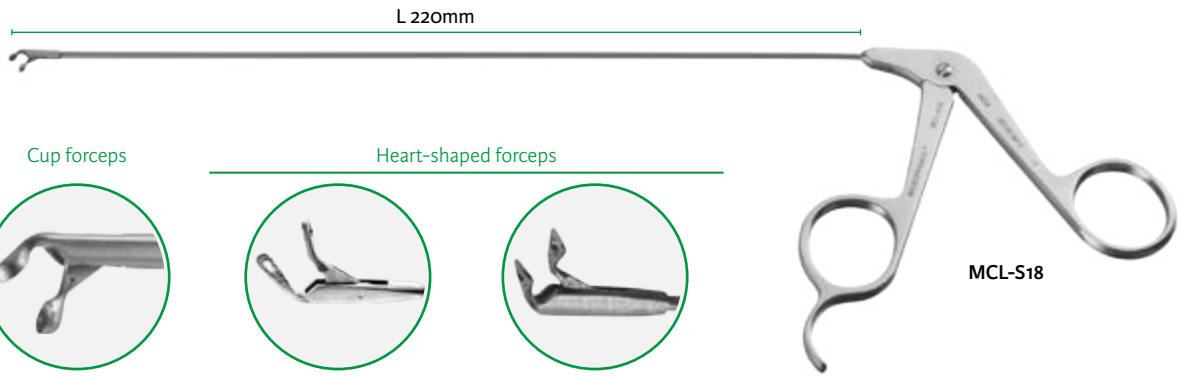

Cup forceps

Heart-shaped forceps

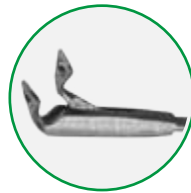

MCL-S18

MCL-S21

MCL-S22

Downward

Right

Left

MCL-S18

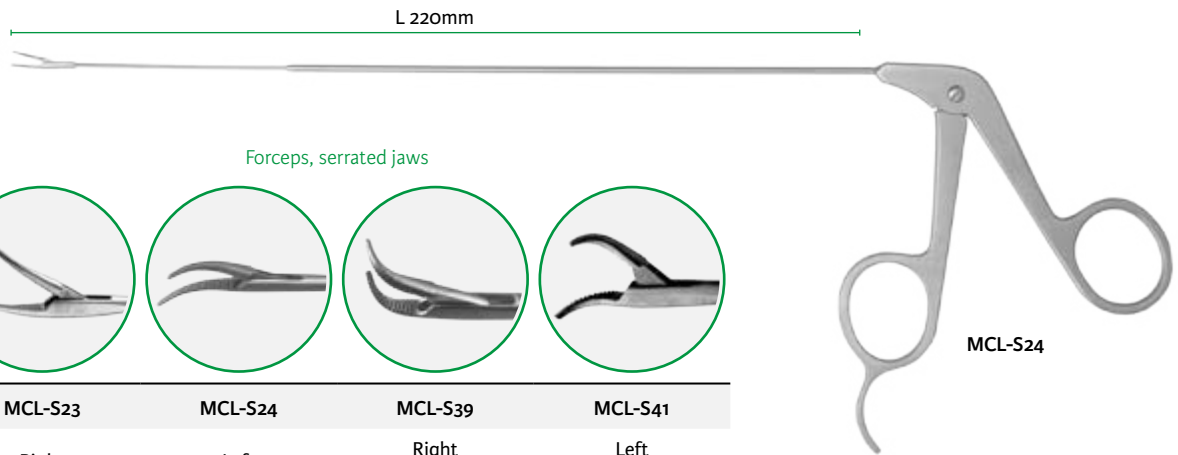

Forceps, serrated jaws



MCL-S23

MCL-S24

MCL-S39

MCL-S41

Right

Left

Right
Large jaws

Left
Large jaws

MCL-S24

Scale 1/3

Sataloff



MCLS28

540x250x70mm

Scale 1/3

Working length 220mm

Benninger

Scissors



MCLB16

MCLB17

MCLB31

Curved right

Curved left

Angled up

Cup forceps



MCLS18R

280mm

Upward

Heart-shaped forceps

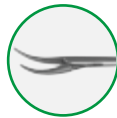

MCL-S21R

MCL-S22R

MCL-S23R

MCL-S24R

Right

Left

Right

Left

Needle-holder



MCLB94

280mm

Angled jaws - 45°

Knot pusher



MCLB30

250mm



MCLB31



MCLS18R



MCL-S22R



MCLB94



MCLB30

Working length «L»

Scale 1/3

Pignat

Laser guide sleeve - Ø 1.5 mm

| | | |
|---------|---------|-------|
| L 120mm | MCL108A | 235mm |
| L 260mm | MCL108B | 375mm |

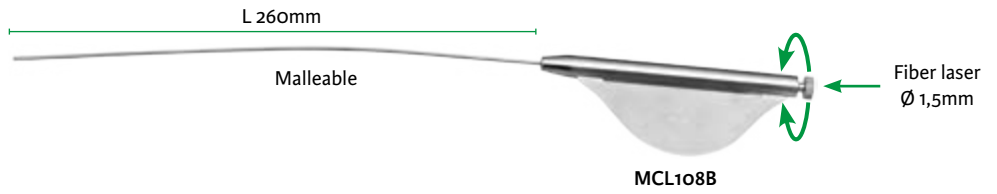

Parsons

Laryngeal sprinkler

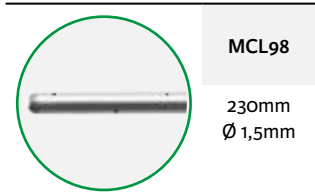

MCL98
230mm
Ø 1,5mm

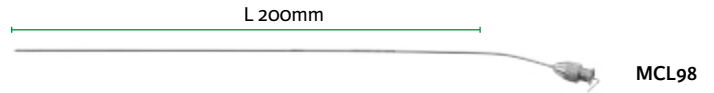

Bouchayer

Retractor forceps



MCL82
310mm

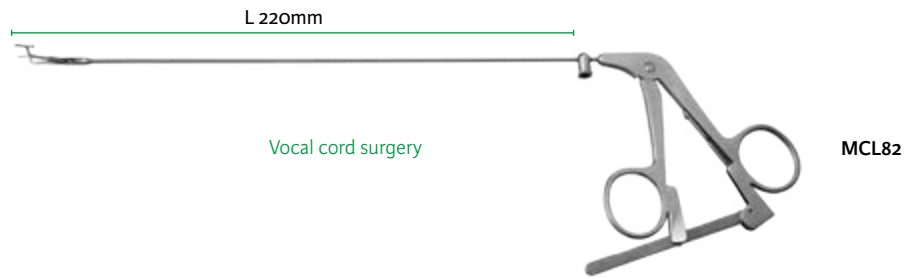

Blunt retractor

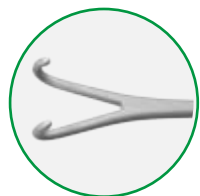

MCL48
320mm
2 prongs



Bouchayer

Needle-holder, straight jaws



MCL94
300mm

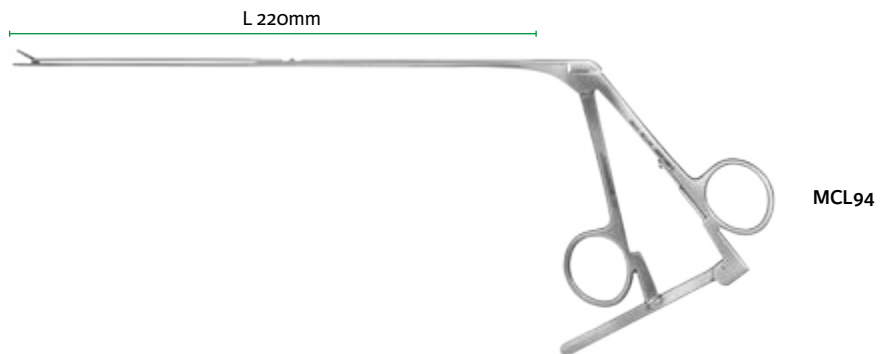

Garabédian

Needle-holder, tungsten jaws



MCL94G
330mm

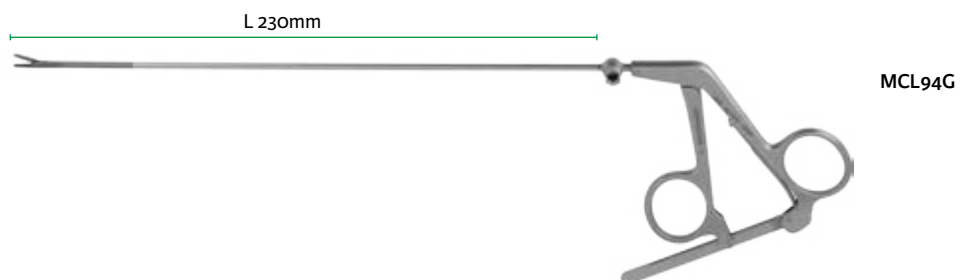

Monopolar instruments

Scale 1/3
Working length «L»

Frèche

Electrode pick, bayonet

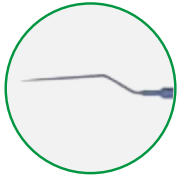

MCL59

360mm



MCL59

Suction tube with finger control

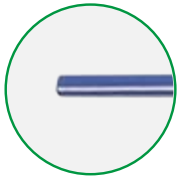

MCL62

300mm
Ø 2,5mm



MCL62

Monopolar cables - 4,5 m



CP391E

Erbe Storz Wolf



CP391M

Aesculap Berchtold Martin Erbe T Serie Lamidey



CP391V

Bowa Emc Lamidey Valleylab

Bipolar forceps

Forceps, straight jaws

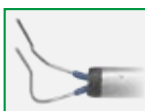

MCL34

340mm
Ø 3,0mm



Delivered with a container

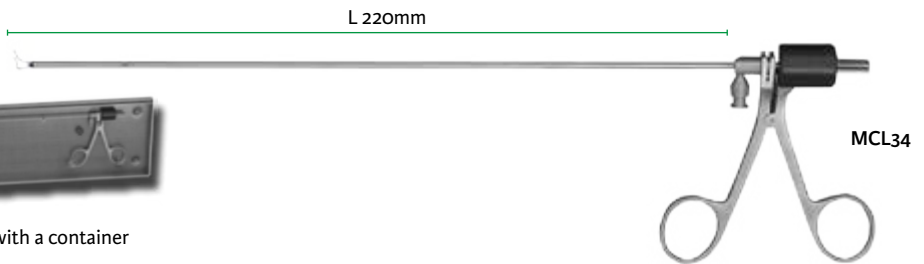

MCL34

Peretti

Forceps, angled jaws



MCL340

270mm - Ø 3,5mm

Jaws 45° - 2,0mm

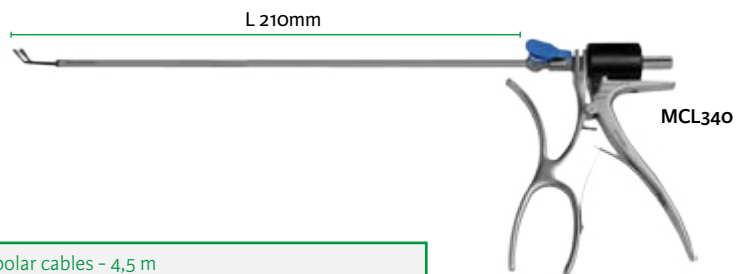

MCL340

Bipolar cables - 4,5 m



CP393-2

Bowa Emc Lamidey Valleylab



CP393-3

Erbe Storz Wolf



CP393-4

Aesculap Berchtold Martin

Scale 1/2

Working length «L»

Injection pistol

Injection pistol

MCL55

Delivered with needle
MCL55-1

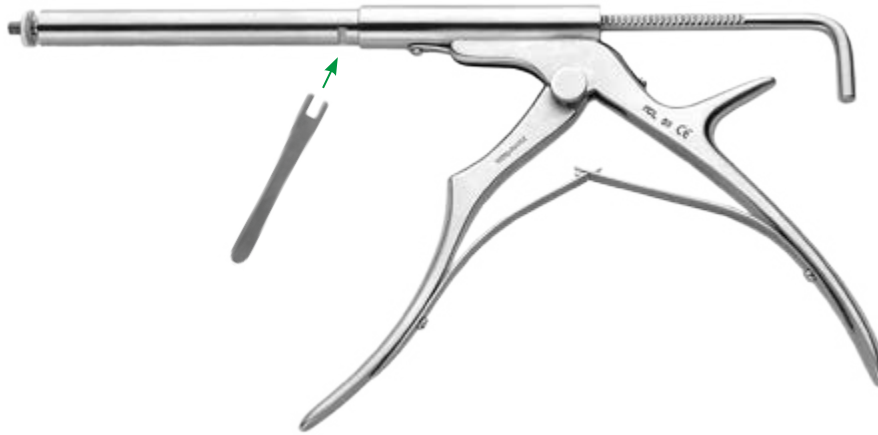

MCL55

Bayonet injection needle

MCL55-1

270mm - Ø 1,0mm

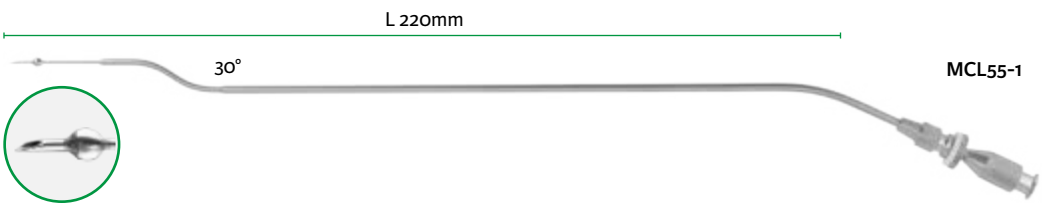

L 220mm

30°

MCL55-1

Injection pistol with luer-lock adapter

Injection pistol

MCL55B

Delivered with adapter
MCL55R



Luer-lock US adapter





MCL55R

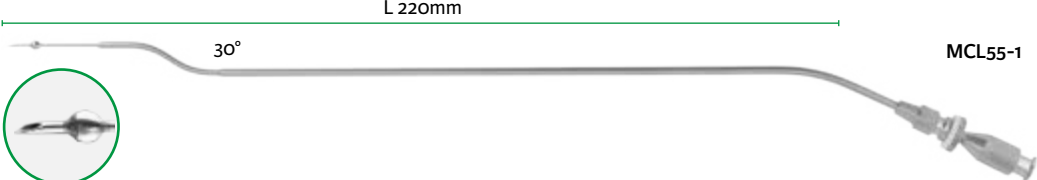

Scale 1/1

Injection needle

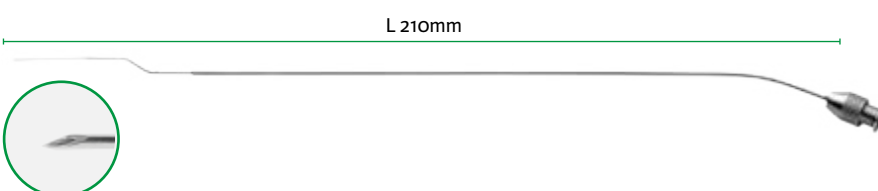
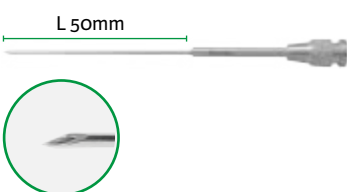
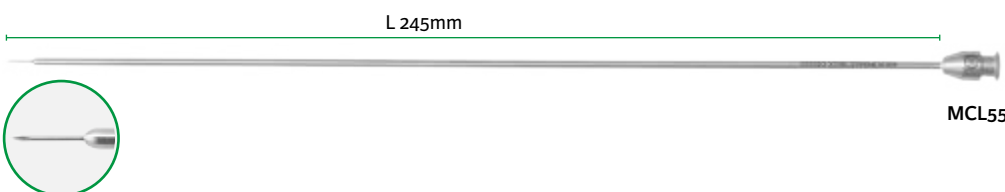
Scale 1/2
Working length «L»

| | |
|---|--|
| <p>Bayonet</p> <hr/> <p>MCL55-1</p> <p>270mm - Ø 1,0mm</p> |  <p>L 220mm</p> <p>30°</p> <p>MCL55-1</p> |
| <p>Bouchayer</p> <hr/> <p>Bayonet curved right</p> <hr/> <p>MCL55-2</p> <p>270mm - Ø 1,0mm</p> |  <p>30°</p> <p>MCL55-2</p> |
| <p>Bouchayer</p> <hr/> <p>Bayonet curved left</p> <hr/> <p>MCL55-3</p> <p>270mm - Ø 1,0mm</p> |  <p>30°</p> <p>MCL55-3</p> |
| <p>Bayonet</p> <hr/> <p>MCL58</p> <p>230mm - Ø 0,5mm</p> <p>Pack 6</p> |  <p>L 210mm</p> <p>MCL58</p> |
| <p>Sataloff</p> <hr/> <p>Straight</p> <hr/> <p>MCL-S35</p> <p>90mm - Ø 1,3mm</p> |  <p>L 50mm</p> <p>MCL-S35</p> |
| <p>Straight, malleable</p> <hr/> <p>MCL55U</p> <p>260mm - Ø 0,5mm</p> <p>Pack 6</p> |  <p>L 245mm</p> <p>MCL55U</p> |

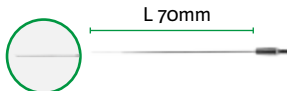
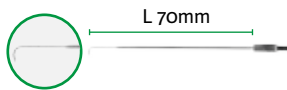
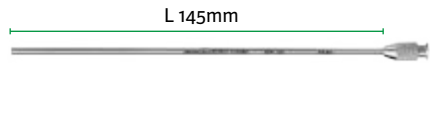
Scale 1/3

| | | | |
|---|---|---|--|
| <p>MCL-S4</p> <p>Pack 6</p> <p>Straight - 80 mm Ø 0.4 mm</p>  <p>L 70mm</p> | <p>MCL-S5</p> <p>Pack 6</p> <p>Angled - 80 mm Ø 0.4 mm</p>  <p>L 70mm</p> | <p>MCL-So</p> <p>Luer-lock adapter, straight 165mm</p>  <p>L 145mm</p> | <p>MCL-S27</p> <p>Luer-lock adapter angled 50mm</p>  |
|---|---|---|--|

Scale 1/2

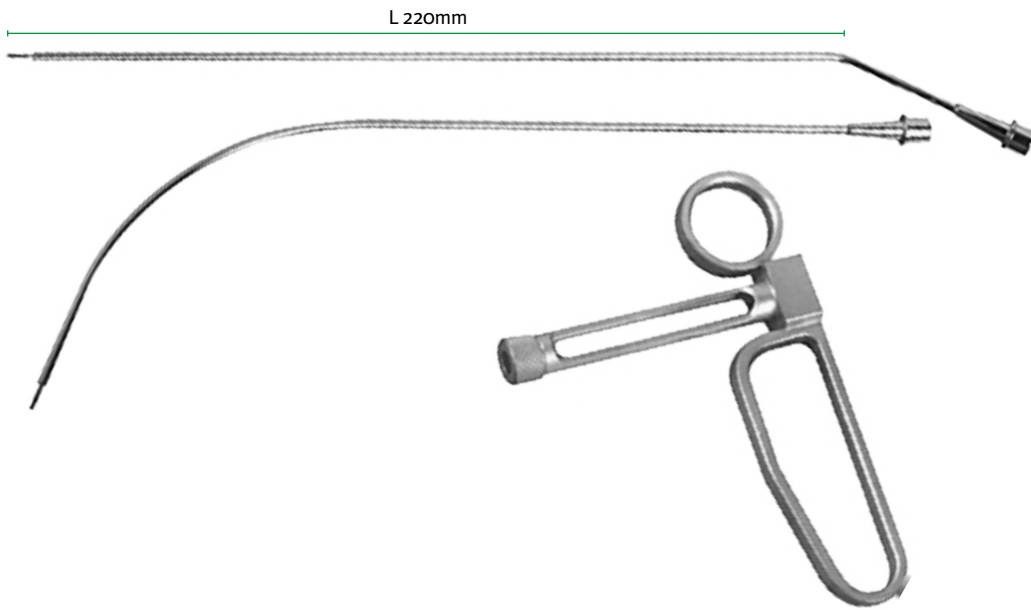

Oro-tracheal injector

with curved and straight
cannula for needle 1650050

1650025

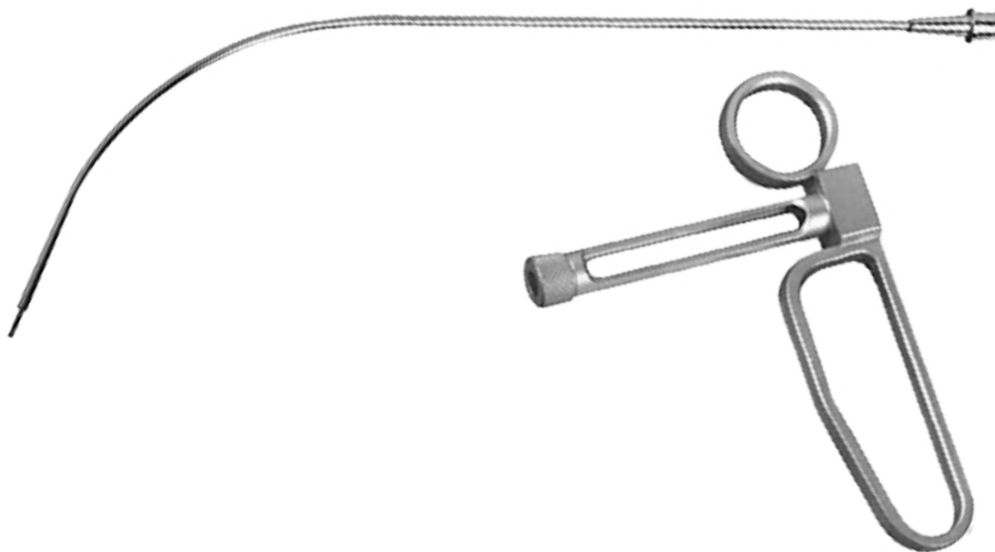

with curved cannula only
for needle 1650050

1650030



Injection needle Oro-tracheal

1650050

Pack 5

Sterile

Scale 2/1

Fenestrated forceps



MCLP20

180mm

Monopolar angled handle

Jaws 8x3mm

Fenestrated forceps

MCLP25

L 100mm

Monopolar axial handle

Jaws 8x3mm



Scale 1/2
Working length «L»

MCLP20

Forceps, alligator jaws



MCLP30

L 95mm

Monopolar axial handle

Jaws 8x3mm



MCLP30

Scissors, curved right



MCLP40

L 95mm

Monopolar axial handle

lames 4mm



MCLP40

Monopolar hook



MCLP50

L 105mm



MCLP50

Blunt tip trocar
55mm



MCLP10

Trocar holder ring
Ø 10mm



MCLP70

Scale 1/2

Double retractor
2 blunt tips
180mm

MCLT10

small size

MCLT11

Large size



MCLT10

MCLT11

Curved elevator 190mm

MCLT20

2mm

MCLT21

4mm



MCLT20

MCLT21

Peanut holder



200mm - Ø 3mm

MCLT30

Axial handle



MCLT30

Suction tube elevator

200mm - Ø 3mm

MCLT40

Malleable



MCLT40

Nerve suction with finger control

200mm - Ø 3mm

MCLT50

Malleable



MCLT50

Scale 1/3
Working length «L»

Monopolar hook



CEV890

L 225mm



CEV890C

90°



Montupet

Retractable knife



CEV898

Pylorotom - L 190mm

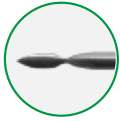

CEV898L

Replacement blades
for CEV898

Pack 3

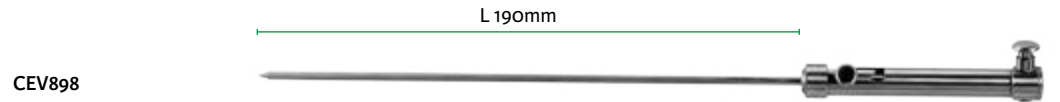

Eyes suction irrigation tube
graduated

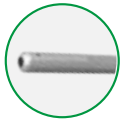

CEV8103G3

L 195mm

graduation 50/100/150mm

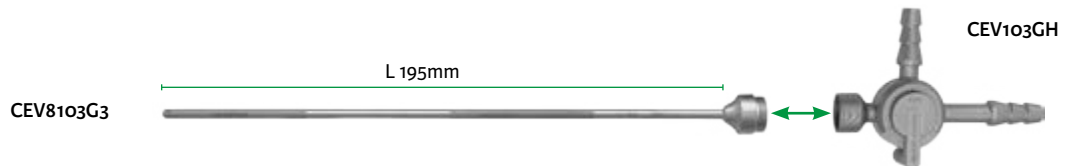

CEV103GH

Handle for suction tube
CEV8103G3

CEV103GH

Eyes suction irrigation tube



CEV896

L 220mm

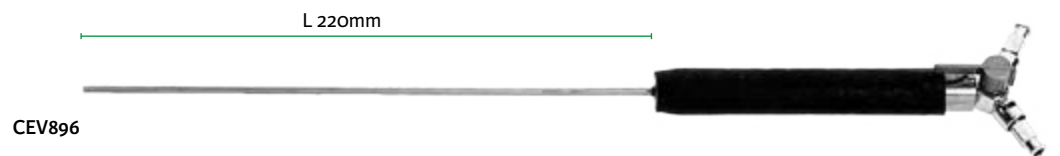















CEV896

Standard

Working length «L»











Complete instruments

| | Jaws Scale 1/1 | | Handle Unscaled | Reference Working length |
|---|---|---|---------------------------------------|-----------------------------|
|  | Bipolar forceps, fenestrated jaws Jaws 10x3mm |  | Ergonomic, bipolar | CEV897BG L 250 mm |
|  | Bipolar forceps, serrated jaws Jaws 1.5mm |  | Angled, bipolaire | CEV897 L 230 mm |
|  | Bipolar forceps, spatulated jaws |  | Ergonomic, bipolar | CEV897C L 250 mm |
|  | Montupet Monopolar forceps, Babcock jaws |  | Angled with long ratchet monopolar | CEV891M L 200 mm |
|  | Montupet Monopolar forceps fenestrated jaws, 12x3mm |  | Angled with long ratchet monopolar | CEV895M L 195 mm |
|  | Montupet Monopolar straight scissors serrated blades 8mm |  | Angled, monopolar | CEV894M L 220 mm |
|  | Montupet Needle-holder, straight tungsten jaws |  | Angled with long ratchet | CEV892 L 220 mm |

| Monopolar cables - 4,5 m | | | Bipolar cables - 4,5 m | | |
|---|---|---|---|---|---|
|  |  |  |  |  |  |
| CP391E | CP391M | CP391V | CP393-2 | CP393-3 | CP393-4 |
| Erbe Storz Wolf | Aesculap Berchtold Martin Erbe T Serie Lamidey | Bowa Emc Lamidey Valleylab | Bowa Emc Lamidey Valleylab | Erbe Storz Wolf | Aesculap Berchtold Martin |

Standard
Complete instruments

Working length «L»

| | Jaws Scale 1/1 | | Handle Unscaled | | Reference Working length |
|--|---|--|--------------------|------------------|-----------------------------|
|  | De Lagausie Monopolar forceps, fenestrated jaws, 12x3mm |  | | Axial, monopolar | CEV995M L 220 mm |
|  | De Lagausie Monopolar straight scissors, serrated blades 8mm |  | | Axial, monopolar | CEV996M L 215 mm |
|  | De Lagausie Monopolar alligator forceps, Serrated jaws, 6mm |  | | Axial, monopolar | CEV997M L 215 mm |
|  | De Lagausie Monopolar dissector |  | | Axial, monopolar | CEV998M L 225 mm |
| <p>Monopolar cables - 4,5 m</p>  <p>CP391E CP391M CP391V</p> <p>Erbe Storz Wolf Aesculap Berchtold Martin Erbe T Serie Lamidey Bowa Emc Lamidey Valleylab</p> | | | | | |
|  | Reinberg Needle-holder tungsten straight jaws |  | | Axial | CEV992 L 220 mm |









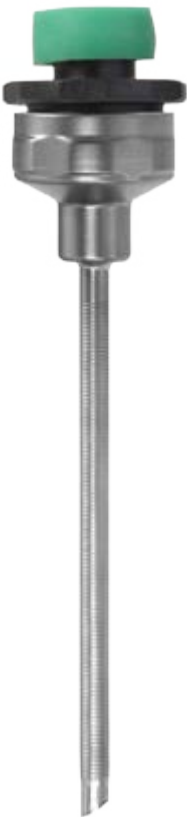

Working length «L»

Trocars

Working length

L 50 mm

L 80 mm

| | | | | | | |
|---|--------------------------|---|--|--|-----------|----------|
|  <p>Scale 1/1</p> | Trocar tip |  | Blunt |  | CEV8143A4 | CEV143A4 |
| | | | Sharp |  | CEV8143A3 | CEV143A3 |
| | Sealing cap | Green |  | CEV103P6 Pack 6 | | |
| | Head of trocar | magnetic valve |  | CEV177A3 | | |
| | | silicone valve |  | CEV127T3 | | |
| | Valve for head of trocar | magnetic |  | CEV179A5 Pack 6 | | |
| | | Silicone |  | CEV125P6 Pack 6 | | |
| | Smooth cannula | with stopcock |  | CEV8143A7 | CEV143A7 | |
| | | without stopcock |  | CEV8143B7 | CEV143B7 | |

Photos for illustration purposes, unscaled



Cup

| | |
|-------------------------|-------|
| 7876-60 ^(D) | 60mm |
| 7876-80 ^(D) | 80mm |
| 7876-100 ^(D) | 100mm |
| 7876-120 ^(D) | 120mm |
| 7876-160 ^(D) | 160mm |



Stainless steel tray

| | |
|------------------------|-----------|
| 7872-24 ^(D) | 240x180mm |
|------------------------|-----------|



MCO731^(D)

Surgical instrument oil

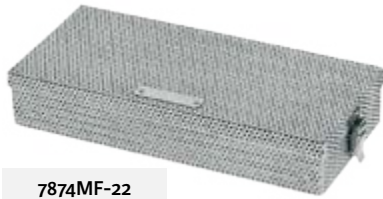

7874MF-22

240x105x45mm
220x100x40mm

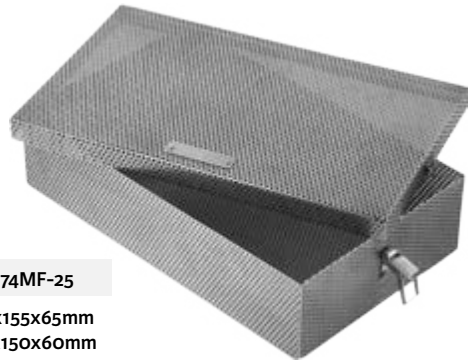

7874MF-25

270x155x65mm
250x150x60mm

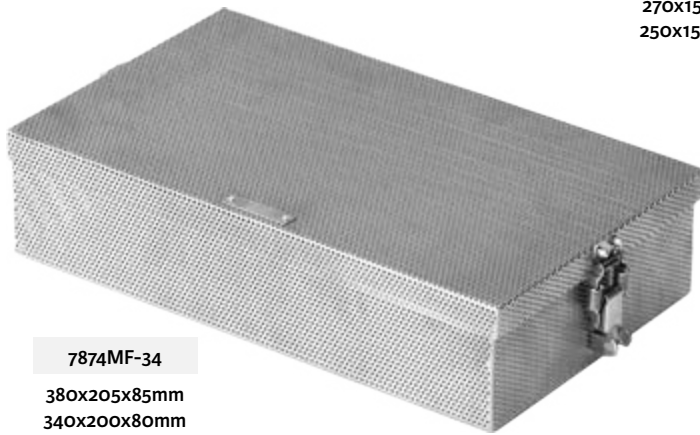

7874MF-34

380x205x85mm
340x200x80mm

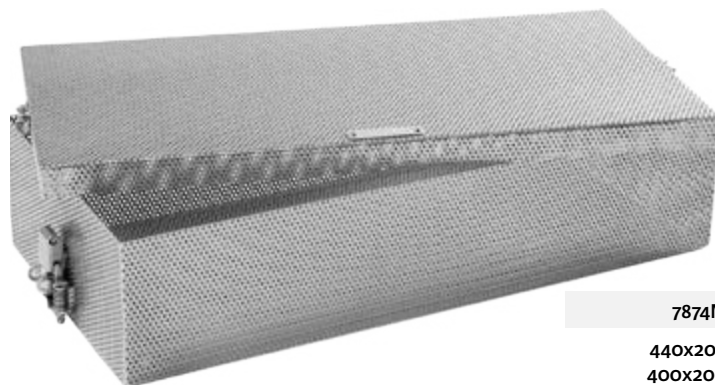

7874MF-40

440x205x95mm
400x200x90mm

^(D) Distributed by Integra MicroFrance SAS (France)

Photos for illustration purposes, unscaled



MCEN136SC
290x175x55mm
270x160x35mm



3717012
380x255x74mm



MCOS10SC
385x256x128mm



3717011
528x250x123mm

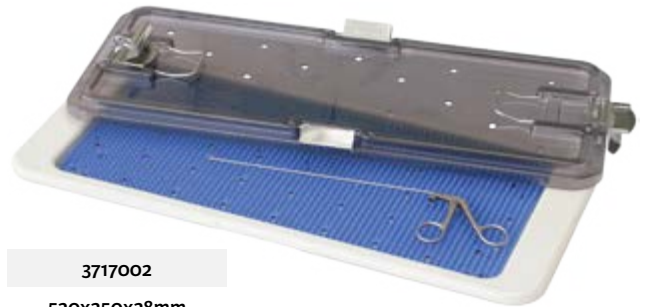

3717002
520x250x28mm



3717000
530x255x140mm



3717006
530x250x140mm

Photos for illustration purposes, unscaled

3717001

530x250x140mm

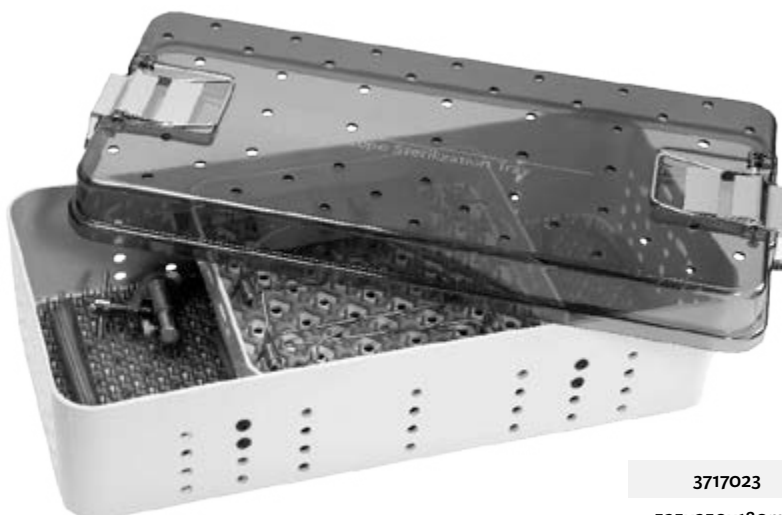

3717023

525x250x180mm

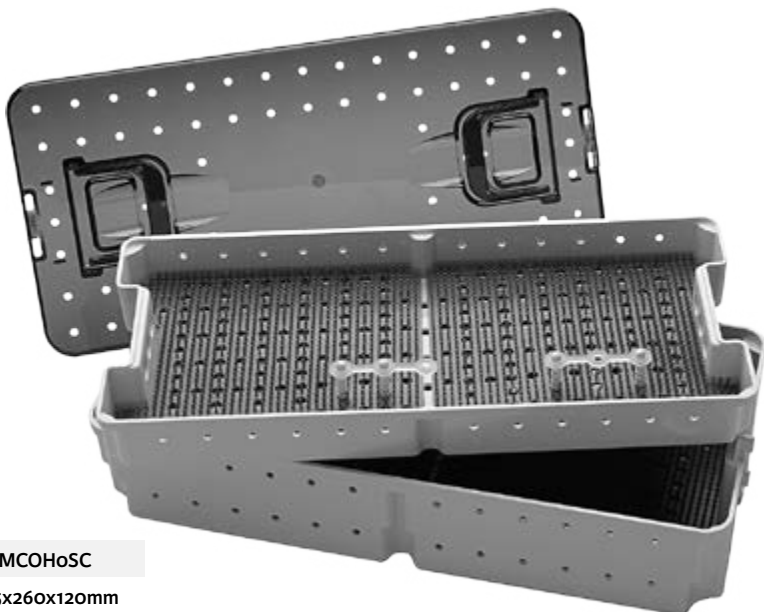

MCOHoSC

545x260x120mm

0

0-28-7 25

1

1003IG^(D) 20
 1003LI^(D) 13, 20
 1004IG^(D) 20
 1005I^(D) 20
 1352247 25
 1352248 25
 1458234 66
 1650025 77
 1650030 77
 1650050 77

3

3711100 42
 3714018 23
 3714027 24
 3714028 24
 3714032 24
 3714044 24
 3714115 19
 3714116 19
 3714184 24
 3714450 3
 3717000 85
 3717001 86
 3717002 85
 3717006 85
 3717011 85
 3717012 85
 3717023 86
 3724059 21
 3724244 25
 3724245 25
 3724333 25
 3731007 12
 3734003 14
 3734004 14
 3734005 14
 3734006 14
 3734007 14
 3734045 13
 3734048 2
 3734049 2
 3734050 2
 3734051 2
 3734052 2
 3734053 2

3734054 2
 3734055 2
 3734056 2
 3734057 2
 3734058 2
 3734059 7
 3734060 6
 3734061 6
 3734062 6
 3734066 6
 3734067 6
 3734068 6
 3734075 6
 3734077 6
 3734079 6
 3734081 6
 3734082 6
 3734092 11
 3734093 11
 3734109 64
 3734110 64
 3734111 64
 3734131 14
 3734132 14
 3734133 14
 3734134 14
 3734147 2
 3734151 7
 3734152 4
 3734155 13
 3734167 16
 3734168 16
 3734218 57
 3734500 59
 3740015 40
 3740019 40
 3740027 38
 3740038 38
 3740067 40
 3740068 17
 3740069 17
 3740071 17
 3740072 17
 3740090 41
 3741011 35
 3741015 36
 3741016 36
 3741017 35
 3741019 36
 3741057 34
 3741065 32
 3741067 33
 3741071 32

3741075 33
 3741080 34
 3741081 34
 3741082 34
 3741083 34
 3744019 50
 3744027 48
 3744031 49
 3744032 49
 3752008 18
 3752011 18
 3755000 53
 3755001 53
 3755002 53
 3755100 54
 3755101 51
 3755102 51
 3755110 51
 3755111 51
 3755114 52
 3755116 52
 3755117 52
 3755129 16
 3755133 52
 3755136 52
 3755152 54
 3755160 53
 3755161 53
 3755162 53

7

701T 49
 702T 48
 703T 48
 704T 48
 714T 48
 720T 49
 7755-1-0-4 15
 7755-1-0-5 15
 7755-1-0-6 15
 7768 23
 7768-1 23
 7773 26
 7781 25
 7782-1-2 24
 7787-10 21
 7796 3
 7797-1 11
 7797-2 11
 7798T^(D) 3
 7798T^(D) 3
 7800MF 11

^(D) Distributed by Integra MicroFrance SAS (France)

| | | | | | |
|-----------------|-------|------------------------------|--------|-------------------------------|----|
| 7802C | 5 | 7831A-18 | 41 | 7876-100 ^(D) | 84 |
| 7802P | 5, 10 | 7831A-20 | 42 | 7876-120 ^(D) | 84 |
| 7802S-1 | 6 | 7832 | 42 | 7876-160 ^(D) | 84 |
| 7802S-2 | 6 | 7833A-12 | 37 | 7879 | 13 |
| 7802S-3 | 6 | 7833A-15 | 39 | 7884 | 13 |
| 7802S-4 | 6 | 7833A-18 | 41 | 7895 | 13 |
| 7802S-5 | 6 | 7833A-20 | 42 | 7920 | 16 |
| 7803B | 4 | 7835 | 16 | 7921 | 16 |
| 7803C | 4 | 7837-18 | 16 | 7923 | 27 |
| 7803S-1 | 6 | 7838 | 16 | 7945T | 50 |
| 7803S-2 | 6 | 7839 | 16 | 7960T40 ^(D) | 10 |
| 7803S-3 | 6 | 7840 | 16 | | |
| 7804-9 | 7 | 7843-1 | 57 | | |
| 7804-11 | 7 | 7843A-1 | 57 | C | |
| 7804-13 | 7 | 7844T3L40 | 56, 57 | CEV103GH | 80 |
| 7805-11 | 7 | 7844T3L45 | 56, 57 | CEV103P6 | 83 |
| 7805-13 | 7 | 7844T3L50 | 56, 57 | CEV125P6 | 83 |
| 7808L-1 | 15 | 7844T3L55 | 56, 57 | CEV127T3 | 83 |
| 7808L-2 | 15 | 7844T3L60 | 56 | CEV143A3 | 83 |
| 7808L-3 | 15 | 7844T5L25 | 57 | CEV143A4 | 83 |
| 7808M | 15 | 7844T5L40 | 56, 57 | CEV143A7 | 83 |
| 7809MF | 7 | 7844T5L45 | 56, 57 | CEV143B7 | 83 |
| 7810 | 15 | 7844T5L50 | 56, 57 | CEV177A3 | 83 |
| 7811 | 13 | 7844T5L55 | 56, 57 | CEV179A5 | 83 |
| 7812 | 13 | 7844T5L60 | 56 | CEV392D20 | 45 |
| 7813 | 15 | 7844T6L40 | 56, 57 | CEV392D30 | 45 |
| 7813-1 | 15 | 7844T6L45 | 56, 57 | CEV392G24 | 45 |
| 7814 | 13 | 7844T6L50 | 56, 57 | CEV392P20 | 45 |
| 7814M | 13 | 7844T6L55 | 56, 57 | CEV392R15 | 45 |
| 7815 | 13 | 7844T6L60 | 56 | CEV392S20 | 45 |
| 7819 | 12 | 7844T74L20 | 57 | CEV417 | 27 |
| 7820 | 12 | 7844T74L25 | 57 | CEV418 | 27 |
| 7821A | 7 | 7844T74L30 | 57 | CEV419 | 27 |
| 7821B | 7 | 7844T74L35 | 57 | CEV890 | 80 |
| 7822 | 12 | 7844T74L40 | 56 | CEV890C | 80 |
| 7823 | 12 | 7844T74L45 | 56 | CEV891M | 81 |
| 7825 | 12 | 7844T74L50 | 56 | CEV892 | 81 |
| 7826-1-7 | 12 | 7844T74L55 | 56 | CEV894M | 81 |
| 7828-1-10 | 14 | 7844T74L60 | 56 | CEV895M | 81 |
| 7828-1-13 | 14 | 7857 | 11 | CEV896 | 80 |
| 7828-1-16 | 14 | 7866-13 | 53 | CEV897 | 81 |
| 7828-1-19 | 14 | 7867-1 | 51 | CEV897BG | 81 |
| 7828-10 | 14 | 7867-2 | 51 | CEV897C | 81 |
| 7828-13 | 14 | 7867-3 | 51 | CEV898 | 80 |
| 7828-16 | 14 | 7867-4 | 51 | CEV898L | 80 |
| 7828-19 | 14 | 7872-24 ^(D) | 84 | CEV984 | 59 |
| 7829-10 | 14 | 7874MF-22 | 84 | CEV992 | 82 |
| 7829-13 | 14 | 7874MF-25 | 84 | CEV995M | 82 |
| 7829-16 | 14 | 7874MF-34 | 10, 84 | CEV996M | 82 |
| 7829-19 | 14 | 7874MF-40 | 84 | CEV997M | 82 |
| 7830M | 16 | 7874MF-61 | 56 | CEV998M | 82 |
| 7831A-12 | 37 | 7876-60 ^(D) | 84 | CEV8103G3 | 80 |
| 7831A-15 | 39 | 7876-80 ^(D) | 84 | CEV8143A3 | 83 |

^(D) Distributed by Integra MicroFrance SAS (France)

| | | | | | |
|----------------|----|---------------|----------------------------|---------------|--------|
| CEV8143A4..... | 83 | CP363..... | 30 | CP818-15..... | 26 |
| CEV8143A7..... | 83 | CP364..... | 35 | CP818-20..... | 26 |
| CEV8143B7..... | 83 | CP365..... | 31 | CP821..... | 20 |
| CP16..... | 28 | CP367..... | 29 | CP821B..... | 20 |
| CP16-1..... | 28 | CP390-1..... | 46 | CP821C..... | 20 |
| CP17..... | 23 | CP390-2..... | 46 | CP821D..... | 20 |
| CP17-1..... | 23 | CP390-3..... | 47 | CP821E..... | 20, 66 |
| CP17-2..... | 23 | CP390-5..... | 47 | CP822-10..... | 23 |
| CP17-3..... | 23 | CP390-7..... | 47 | CP822-12..... | 23 |
| CP21-3..... | 24 | CP390-8..... | 46 | CP822-14..... | 23 |
| CP21A-3..... | 24 | CP390L26..... | 47 | CP825..... | 21 |
| CP37..... | 37 | CP391E..... | 13, 46, 47, 68, 74, 81, 82 | CP914..... | 35 |
| CP310..... | 22 | CP391M..... | 13, 46, 47, 68, 74, 81, 82 | CP919..... | 28 |
| CP310D..... | 22 | CP391V..... | 13, 46, 47, 68, 74, 81, 82 | CP919A..... | 28 |
| CP310E..... | 22 | CP392-1R..... | 43 | CP921..... | 31 |
| CP330-3-0..... | 55 | CP392-2R..... | 43 | CP922..... | 30 |
| CP330-4-0..... | 55 | CP392-8R..... | 43 | CP922A..... | 30 |
| CP332..... | 37 | CP392BI..... | 43 | CP922B..... | 30 |
| CP335..... | 24 | CP392BS..... | 43 | CP931..... | 32 |
| CP335P..... | 27 | CP393-2..... | 43, 44, 45, 74, 81 | CP931-1..... | 32 |
| CP344A..... | 22 | CP393-3..... | 43, 44, 45, 74, 81 | CP931-3..... | 33 |
| CP344AT..... | 22 | CP393-4..... | 43, 44, 45, 74, 81 | CP931-5..... | 33 |
| CP344B..... | 22 | CP400..... | 39, 41 | CP933-14..... | 39 |
| CP344BT..... | 22 | CP400-1..... | 37 | CP933-16..... | 40 |
| CP344C..... | 22 | CP401..... | 40 | CP933-18..... | 41 |
| CP344CT..... | 22 | CP406..... | 37 | CP934..... | 39 |
| CP344D..... | 22 | CP407..... | 39 | CP934-1..... | 39 |
| CP344DT..... | 22 | CP409..... | 41 | CP936..... | 40 |
| CP344E..... | 22 | CP414..... | 37 | CP938-1..... | 37 |
| CP344ET..... | 22 | CP415..... | 39 | CP941..... | 23 |
| CP345..... | 40 | CP604..... | 38 | CP984..... | 26 |
| CP351-1..... | 33 | CP604-15..... | 38 | CP984-1..... | 26 |
| CP351-2..... | 32 | CP604BR..... | 43 | CP985..... | 19 |
| CP351-3..... | 32 | CP604M..... | 46 | CP988-15..... | 39 |
| CP351-5..... | 33 | CP605..... | 38 | CP988-18..... | 41 |
| CP351-6..... | 32 | CP605-15..... | 38 | CP988-20..... | 42 |
| CP351-7..... | 32 | CP605BR..... | 43 | CP997..... | 29 |
| CP352..... | 34 | CP605M..... | 46 | CP1107..... | 48 |
| CP352-1..... | 34 | CP606..... | 38 | | |
| CP352-2..... | 34 | CP606-15..... | 38 | | |
| CP352-3..... | 34 | CP606A..... | 38 | | |
| CP353..... | 28 | CP609..... | 24 | | |
| CP354..... | 28 | CP611..... | 19 | | |
| CP354A..... | 28 | CP616-13..... | 31 | | |
| CP355..... | 29 | CP616-15..... | 31 | | |
| CP355A..... | 29 | CP625..... | 19 | | |
| CP355C..... | 31 | CP626..... | 19 | | |
| CP356..... | 28 | CP627..... | 19 | | |
| CP357-1..... | 36 | CP628..... | 23 | | |
| CP357-2..... | 36 | CP637..... | 30 | | |
| CP358..... | 28 | CP818-8..... | 26 | | |
| CP358A..... | 28 | CP818-10..... | 26 | | |
| CP362..... | 29 | CP818-12..... | 26 | | |

M

| | |
|-----------------|--------|
| M832..... | 38 |
| M833..... | 38 |
| MCEN136SC..... | 18, 85 |
| MCEN770J30..... | 55 |
| MCEN770J40..... | 55 |
| MCL1BIS..... | 66 |
| MCL10..... | 64 |
| MCL11..... | 66 |
| MCL12..... | 65 |
| MCL15..... | 65 |
| MCL16..... | 66 |
| MCL17..... | 66 |

| | | | | | |
|-----------------------------|--------|--------------------------------|------------|-----------------|--------|
| MCL18 | 65 | MCL75 | 59 | MCL201 | 5 |
| MCL19 | 65 | MCL76 | 10, 59 | MCL205 | 68 |
| MCL19BIS | 65 | MCL77 | 61 | MCL206A1 | 8, 9 |
| MCL25 | 65 | MCL78 | 61 | MCL206A2 | 9 |
| MCL29 | 65 | MCL79 | 61 | MCL206A3 | 9 |
| MCL30 | 65 | MCL81BL | 67 | MCL206A4 | 9 |
| MCL31 | 66 | MCL81BR | 67 | MCL206A5 | 9 |
| MCL33 | 65 | MCL81PL | 67 | MCL206C | 8, 9 |
| MCL34 | 74 | MCL81PR | 67 | MCL206K | 9 |
| MCL35 | 10, 59 | MCL82 | 73 | MCL206P | 8, 9 |
| MCL37 | 60 | MCL83 | 62 | MCL210 | 64, 68 |
| MCL37C | 60 | MCL83-1 | 62 | MCL219 | 68 |
| MCL37CF | 60 | MCL84 | 62 | MCL219-1 | 68 |
| MCL37D | 60 | MCL88 | 58 | MCL241 | 68 |
| MCL37DF | 60 | MCL88-1 | 58 | MCL241-1 | 68 |
| MCL37G | 60 | MCL88-2 | 58 | MCL290 | 62 |
| MCL38N ^(D) | 10, 59 | MCL89 | 62 | MCL291 | 62 |
| MCL42 | 60 | MCL89-1 | 10, 58, 62 | MCL291AD | 62 |
| MCL46 | 62 | MCL89-2 | 10, 62 | MCL291AG | 62 |
| MCL46A | 62 | MCL92-1 | 66 | MCL291FD | 62 |
| MCL47 | 62 | MCL93 | 66 | MCL291FG | 62 |
| MCL48 | 73 | MCL93-2 | 66 | MCL294 | 62 |
| MCL49 | 58 | MCL94 | 73 | MCL295 | 62 |
| MCL49F | 58 | MCL94G | 73 | MCL330 | 56 |
| MCL51 | 60 | MCL98 | 73 | MCL330F | 56 |
| MCL52 | 60 | MCL100 | 10, 64 | MCL340 | 74 |
| MCL53 | 60 | MCL100T15 | 64 | MCL920L30 | 58 |
| MCL54 | 60 | MCL100T20 | 64 | MCL920L45 | 56, 57 |
| MCL55 | 75 | MCL103 | 64 | MCL920L55 | 56, 57 |
| MCL55-1 | 75, 76 | MCL108A | 73 | MCL925L30 | 58 |
| MCL55-2 | 76 | MCL108B | 73 | MCL925L45 | 56, 57 |
| MCL55-3 | 76 | MCL110 | 57 | MCL925L55 | 56, 57 |
| MCL55B | 75 | MCL111 | 57 | MCL930L25 | 57 |
| MCL55R | 75 | MCL112 | 57 | MCL930L30 | 58 |
| MCL55U | 76 | MCL112F | 57 | MCL930L45 | 56, 57 |
| MCL56BL | 67 | MCL112H | 56, 57 | MCL930L55 | 56, 57 |
| MCL56BR | 67 | MCL120 | 63 | MCL935L30 | 58 |
| MCL56PL | 67 | MCL121 | 63 | MCL935L45 | 56, 57 |
| MCL56PR | 67 | MCL122 | 63 | MCL935L55 | 56, 57 |
| MCL57 | 66 | MCL123 | 63 | MCL940L30 | 58 |
| MCL58 | 76 | MCL124 | 63 | MCL940L45 | 56, 57 |
| MCL59 | 74 | MCL124FL | 63 | MCL940L55 | 56, 57 |
| MCL62 | 74 | MCL124FR | 63 | MCLB16 | 72 |
| MCL63 | 61 | MCL124ST | 63 | MCLB17 | 72 |
| MCL63F | 61 | MCL125 | 63 | MCLB30 | 72 |
| MCL64 | 61 | MCL125FL | 63 | MCLB31 | 72 |
| MCL64F | 61 | MCL125FR | 63 | MCLB94 | 72 |
| MCL65A | 62 | MCL170 ^{(D)(i)} | 10, 59 | MCLP10 | 78 |
| MCL65AF | 62 | MCL171 ^{(D)(i)} | 10, 59 | MCLP20 | 78 |
| MCL65AS | 62 | MCL173 ^{(D)(i)} | 10, 59 | MCLP25 | 78 |
| MCL67 | 65 | MCL174 ^{(D)(i)} | 10, 59 | MCLP30 | 78 |
| MCL68 | 65 | MCL197 ^{(D)(i)} | 10, 59 | MCLP40 | 78 |
| MCL69 | 65 | MCL200 | 5 | MCLP50 | 78 |

⁽ⁱ⁾ Not a MEDICAL DEVICE

^(D) Distributed by Integra MicroFrance SAS (France)

MCLP70..... 78
MCL-S0 76
MCL-S1 69
MCL-S2 69
MCL-S3..... 69
MCL-S4 76
MCL-S5..... 76
MCL-S6 69
MCL-S7..... 69
MCL-S8 69
MCL-S9 69
MCL-S10..... 69
MCL-S11..... 69
MCL-S12 69
MCL-S13 69
MCL-S14 69
MCL-S15 69
MCL-S16 64
MCL-S17 64
MCL-S17-1 64
MCL-S18 70
MCL-S18R..... 72
MCL-S19 69
MCL-S21..... 70
MCL-S21R..... 72
MCL-S22 70
MCL-S22R..... 72
MCL-S23..... 70
MCL-S23R 72
MCL-S24 70
MCL-S24R 72
MCL-S27..... 76
MCLS28..... 71
MCL-S35..... 76
MCL-S38..... 69
MCL-S39 70
MCL-S41..... 70
MCLS120-1..... 63
MCLS120-2 63
MCLS120-3 63
MCLS121-1..... 63
MCLS121-2 63
MCLS121-3 63
MCLS122-1 63
MCLS122-2 63
MCLS122-3 63
MCLS123-1 63
MCLS123-2..... 63
MCLS1233 63
MCLT10 79
MCLT11 79
MCLT20..... 79
MCLT21 79

MCLT30..... 79
MCLT40..... 79
MCLT50..... 79
MCLW10..... 66
MCLW11..... 66
MCM1R..... 18
MCM4BISR 17
MCM4R 17
MCM7BISR..... 18
MCM7R 18
MCM9^(D) 17
MCM10-0-5..... 17
MCM10-1-0 17
MCM12R 18
MCM13 17
MCM13-1 17
MCM25-3..... 10, 18
MCM970 18
MCM973D3..... 17
MCM973D5 17
MCO305..... 19
MCO731^(D)..... 84
MCO770-1-5 55
MCO770-2-0 55
MCO770-2-5 55
MCO770-3-0 55
MCO770-3-5 55
MCO770-4-0 55
MCO771-2-5 55
MCO771-3-0 55
MCO771-4-0..... 55
MCO803..... 19
MCO979 21
MCO988..... 21
MCOHoSC..... 86
MCOS1oSC 85
MCR2A 6
MCR3A 6

P769 53
P770 54
P771..... 54

S

SM63^(D) 20, 66
SM64^(D) 20, 66
SM65^(D) 20, 66

P

P761-7 51
P761-8..... 51
P762-2 52
P762-4 52
P763 53
P764-1..... 52
P764-3 52
P764-5 52
P764-7..... 52
P764-11 52
P765-14 53
P765-16 53

^(D) Distributed by Integra MicroFrance SAS (France)

Integra® MicroFrance®

Integra ENT - Throat catalogue

Manufacturers :



Integra MicroFrance SAS (France)
Le Pavillon ■ 03160 Saint Aubin le Monial ■ France



Medtronic Xomed
6743 Southpoint Drive N.
Jacksonville 32216-0980 ■ Florida USA



Medtronic B.V.
Earl Bakkenstraat 10
6422 PJ Heerlen ■ The Netherlands



Swann Morton Ltd
Penn Works ■ Owlerton Green ■ Sheffield
South Yorkshire S6 2BJ ■ Royaume Uni

Manufacturers with CE class I products only :



Agencinox
Zone Industrielle
89110 Aillant sur Tholon ■ France



Chemische Fabrik Dr. Weigert GmbH & Co.
Mühlenhagen
D-20539 Hamburg ■ Allemagne



Moria S.A.
15, rue Georges Besse
92160 Antony ■ France



Directa AB
Box 723
19427 Upplands Vasby ■ Suède



Sunoptic Technologies
6018 Bowdendale Avenue
Jacksonville 32216 ■ Florida USA



RMS - UK Limited
28 Trinity Road ■ Nailsea
Somerset BS48 4NU ■ Royaume Uni

Availability of these products might vary from a given country or region to another, as a result of specific local regulatory approval or clearance requirements for sale in such country or region.

- Please read carefully the instructions for use.
- Non contractual document. The manufacturer reserves the right, without prior notice, to modify the products in order to improve their quality.
- Warning: Applicable laws restrict these products to sale by or on the order of a physician.

Additional information for EMEA Customers only :

Products mentioned in this document are CE class I or IIa devices. Contact Integra should you need any additional information on devices classification. All the medical devices mentioned on this document are CE marked according to European council directive 93/42/EEC on medical devices and its relatives.

References that are not medical devices are identified with the indication "NOT A MEDICAL DEVICE".

Products marked with the symbol [®] are distributed by Integra MicroFrance SAS (France)

Date of last révision : 06/2015

For more information, please contact customer service :

Europe, Middle-East, Africa

France / International : +33 (0) 470 67 98 00 ■ +33 (0) 470 67 98 20 (Fax) ■ microfrance@integralife.com
United Kingdom : +44 (0) 1264 312 725 ■ +44 (0) 1264 312 821 (Fax) ■ custsvcuk@integralife.com
Germany : +49 (0) 2102 5535 6200 ■ +49 (0) 2102 5536 636 (Fax) ■ custsvcgermany@integralife.com
Benelux: +32 (0)2 257 4130 ■ +32 (0)2 253 2466 (Fax) ■ custsvcbenelux@integralife.com
integralife.eu/contact

Integra and the Integra logo are registered trademarks of Integra LifeSciences Corporation or its subsidiaries in the United States and/or other countries.

MicroFrance is a trademark of Integra LifeSciences Corporation or its subsidiaries.

All other trademarks and product names are the property of their respective owners.

©2015 Integra LifeSciences Corporation. All rights reserved.

Printed in France. 0335699-1-EN

DOCUMENT FOR USE IN EUROPE, MIDDLE-EAST AND AFRICA ONLY.